

DEMAG[®]
A TEREX BRAND

All Terrain Crane AC120/4J



- ▶ ブーム装着4軸車両クレーンで吊上げ性能120トンクラス
- ▶ 50m伸縮ブーム、最大27m補助ジブ(オプション)
- ▶ 車両長さ : 13.28m
車両幅 : 2.55m
車両高さ : 3.860m



DEMAG

A TEREX BRAND



CONTENTS

凡例	04
寸法図	05
カウンタウエイト	06
装備品	07
主要諸元	08

HA

メインブーム

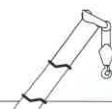

09

HAVHY

油圧オフセット式補助ジブ



19

HAVHY-VA

油圧オフセット式追加補助ジブ
(追加オプション仕様)



27

技術的な説明	30
--------	----

	カウンタウエイト		作業速度
	アウトリガ張出し吊能力		最大ラインプル
	作業半径		ロープ直径
	メインブーム		ロープ長さ
	オフセット式補助ジブ		フックブロック (能力・シーブ数・ロープ直径)
	最大軸荷重		ロープ掛け本数
	機構		アダプター
	タイヤ		フックブロック能力
	フックブロック		フックブロック質量
	ホイスト		フック巻上限界距離
	走行速度		ブームヘッドシーブ数
	道路登坂能力(オンロード) %		アウトリガ反力
	非道路登坂能力(オフロード) %		ストローク(ジャッキシリンダ)
	旋回		ブーム起伏
	ブーム伸縮		追加油圧システム

寸法図

走行状態

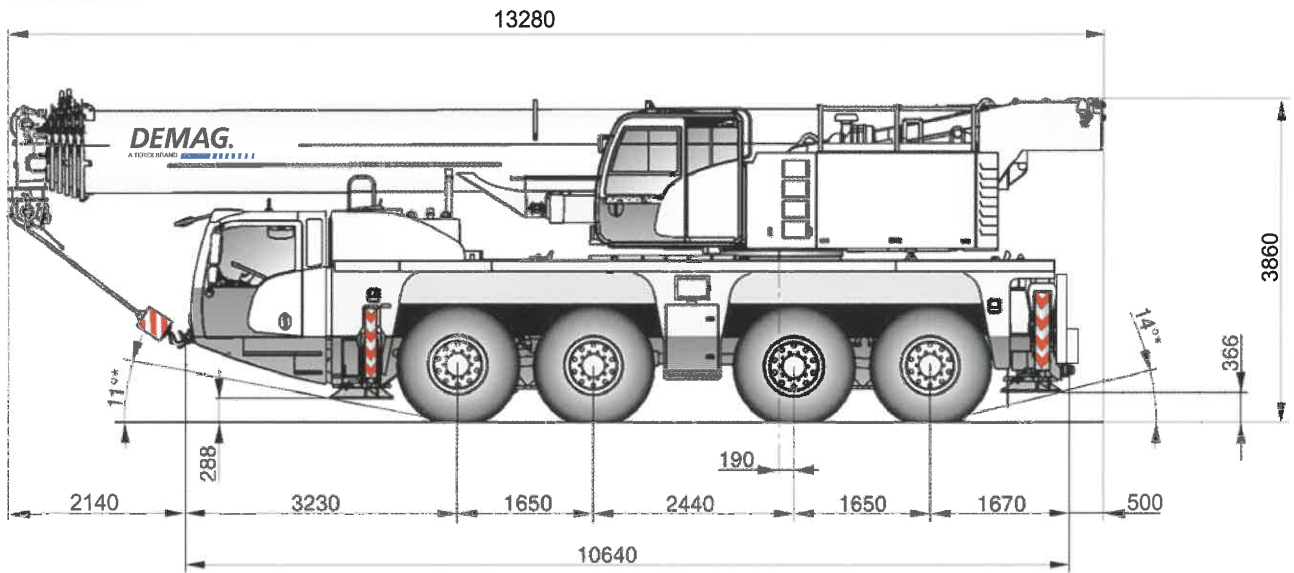

作業状態

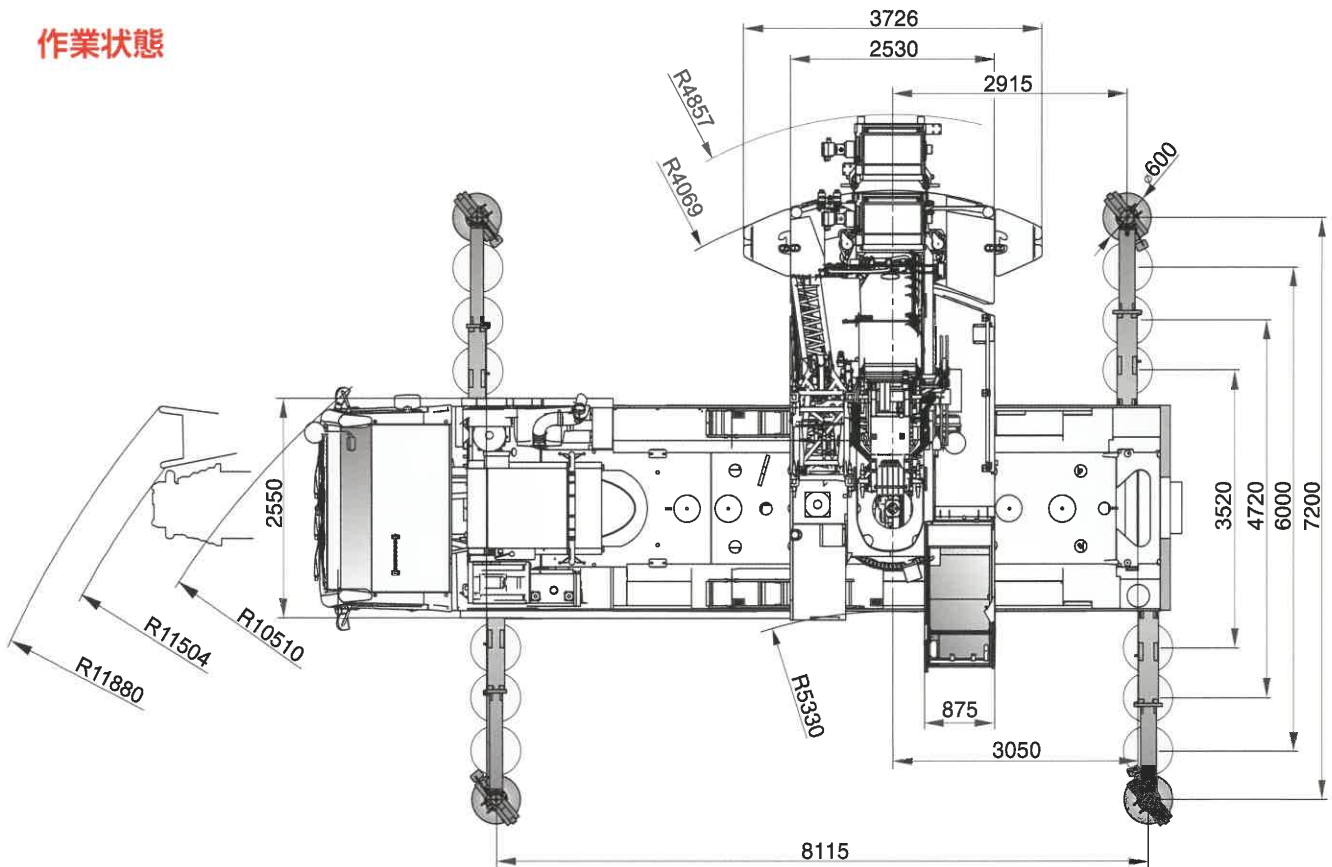

COUNTERWEIGHT

AC120/4J

カウンタウエイト

部材構成

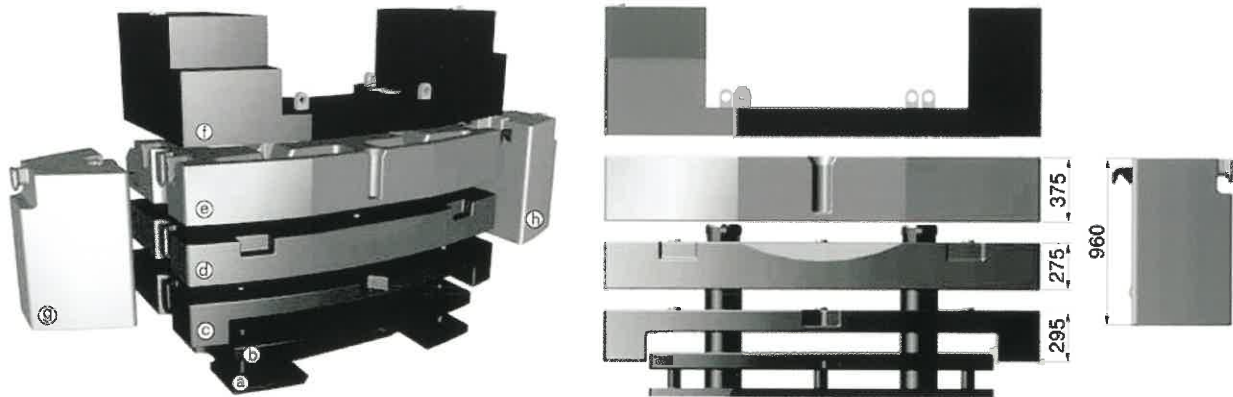

重量構成

	Ⓐ 0,7t	Ⓑ 1,5t	Ⓒ 3,2t	Ⓓ 5,2t	Ⓔ 6,0t	Ⓕ 4,7t	Ⓖ 2,4t	Ⓗ 2,4t
0,7 t	X							
2,2 t	X	X						
3,9 t	X		X					
4,7 t						X		
5,4 t	X					X		
5,4 t	X	X	X					
6,9 t	X	X				X		
8,6 t	X		X			X		
9,1 t	X		X	X				
10,1 t	X	X	X			X		
10,6 t	X	X	X	X				
13,8 t	X		X	X		X		
15,1 t	X		X	X	X			
* 15,3 t	X	X	X	X		X		
16,5 t	X	X	X	X	X			
19,8 t	X		X	X	X	X		
* 19,9 t	X		X	X	X		X	X
21,3 t	X	X	X	X	X	X		
* 21,4 t	X	X	X	X	X		X	X
24,6 t	X		X	X	X	X	X	X
26,1 t	X	X	X	X	X	X	X	X

*上段の荷重表が適用されます。

フックブロック

フック	重量 (t)	個数	吊り上げ高さ (m)	重量 (kg)	吊り上げ高さ (m)
1	6.6	0	5	170	1.00m
2	19.6	1	5	350	1.80m
3	44.0	3	5	550	1.80m
4	66.5	5	5+S1	650	2.00m

DEMAG®

A TEREX BRAND

装備品

HAVHY-VA

油圧オフセット式追加補助ジブ ※追加オプション仕様

HAVHY-VA 27-27

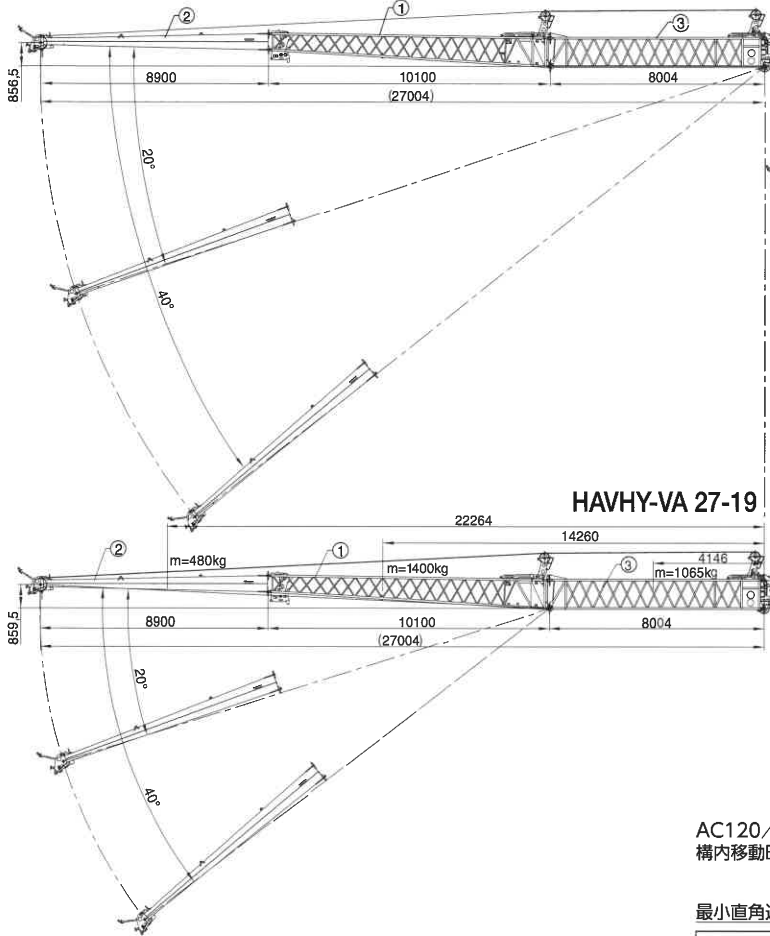

HAVHY-VA 27-19

HAVHY

油圧オフセット式補助ジブ

HAVHY 19

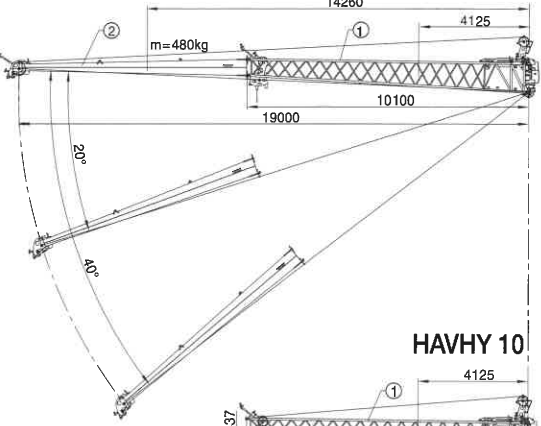

HAVHY 10

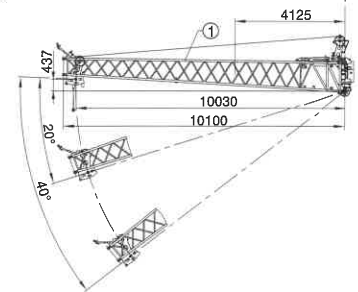

AC120/4Jオールテレーンクレーン
構内移動時走行軌跡図

最小直角通路

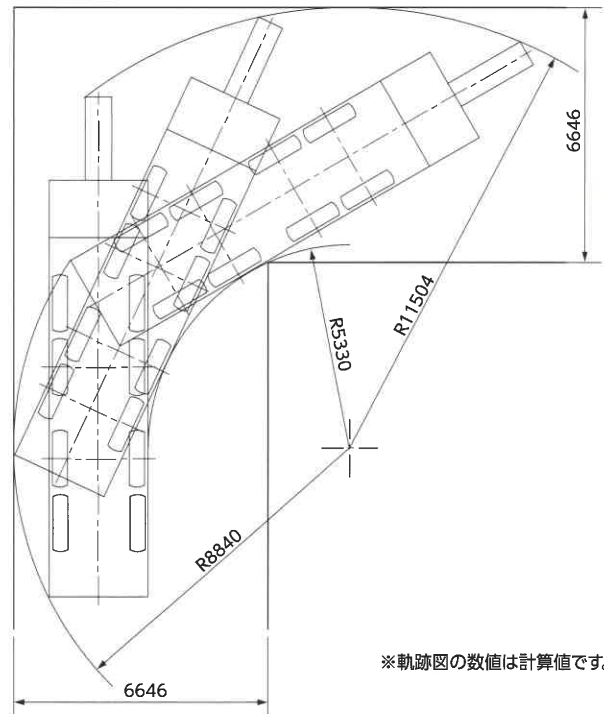

※軌跡図の数値は計算値です。

キャリア走行

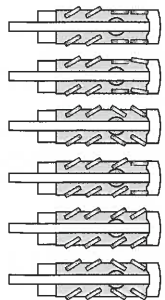

- 1 道路走行 > 45 km/h
- 2 市街地走行 < 45 km/h
- 3* 最小回転半径 < 5 km/h
- 4* 離壁走行
- 5* 蟹走行
- 6* 手動走行

* 走行時に切り替え選択

主要諸元

● キャリア性能

エンジン名称	ダイムラーAG
エンジン型式	OM460LA, E3A/2
最大トルク	2000 Nm / 1,300rpm
最大出力	335kW(450HP) / 1,800rpm
燃料タンク容量	410 リットル
駆動方式	8×6×8 駆動軸 1.2.4
ステアリング軸	1.2.3.4
アウトリガ装置	全油圧式H型 単独操作式
主ブレーキ	ABS付2系統圧縮式エアブレーキ、全軸に効力 トランスミッションに一体式油圧リターダ 排気ブレーキ
	エンジンコンティニアンスロットルブレーキ
	駐車・非常ブレーキ
駐車・非常ブレーキ	1.2.4軸にスプリング負荷ブレーキ

● 走行性能

最高速度	80km/h
登坂能力(tanθ)	34.9° (70%)

● 作業速度

ロープ 巻上速度	ホイスT1	115 m / min
	ホイスT2	115 m / min
旋回速度		1.4 rpm
ブーム起伏速度		60 秒
ブーム伸縮速度		490 秒

● クレーン

エンジン	名称	ダイムラーAG
	型式	OM904LA
	出力	129kW(175HP)/2,200rpm
ブーム長	メインブーム	11.9m ~ 50.0m
	ジブ	10.1m / 19.0m / 27.0m (オプション)
ブーム形式		箱型5段
補助ジブ形式		ブーム横折曲格納式2段
ブーム伸縮装置		複動油圧シリンダ直押し1本
ブーム起伏装置		単動油圧シリンダ直押し1本
巻上げ装置		油圧モーター駆動遊星歯車減速式
旋回装置		油圧モーター駆動遊星歯車減速式

● ワイヤー

ワイヤーロープ(H1)	径18mm×長さ265m 非自転性ワイヤーロープ
ワイヤーロープ(H2)	径18mm×長さ265m 非自転性ワイヤーロープ



● 安全装置

安全装置	過負荷防止装置、巻過防止装置
	玉掛けロープ外れ止め、捨巻確保装置
	ホイスドラム回転検出器、油圧安全弁
	旋回ロック装置、水準器、張出幅検出装置

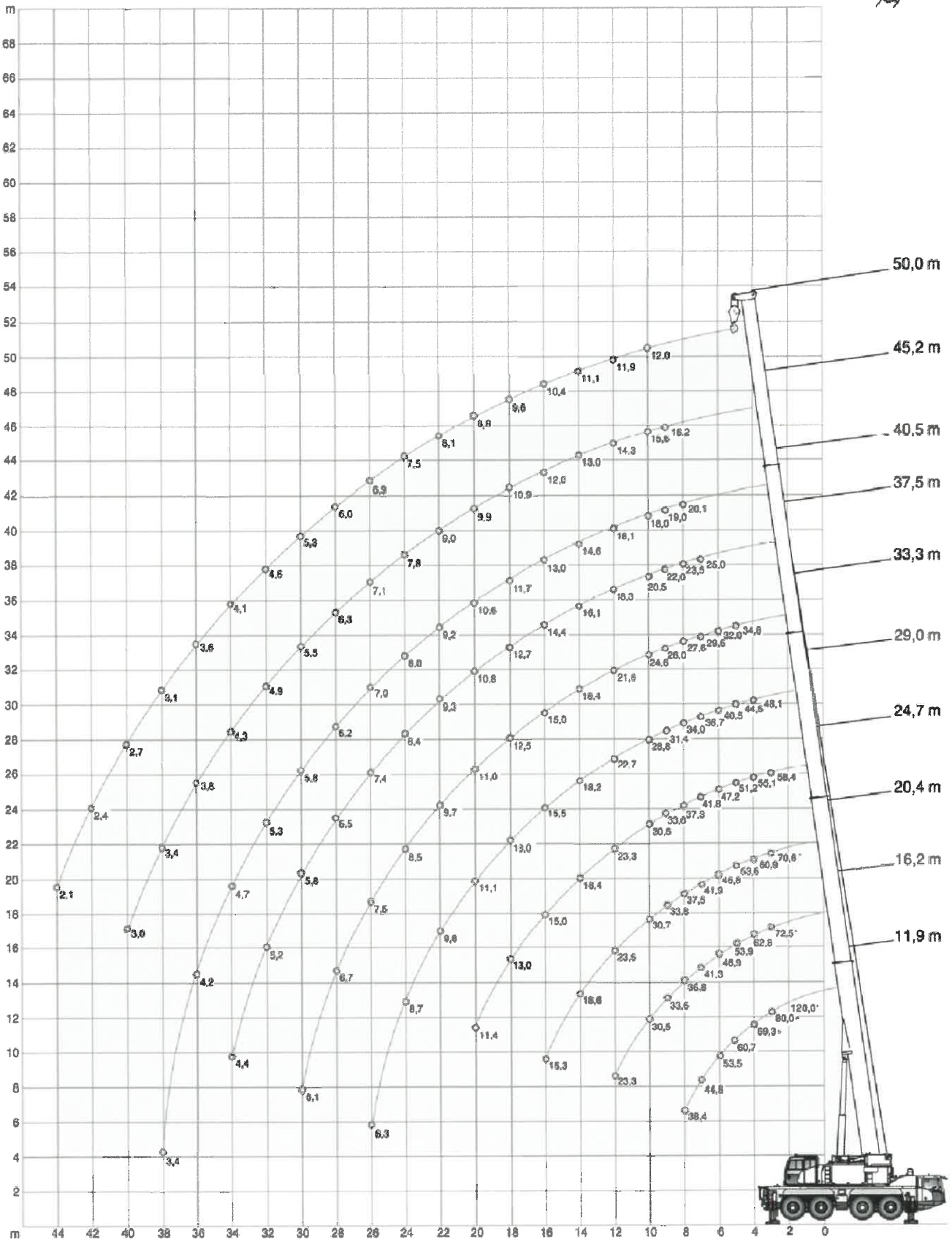
メインブーム作業範囲図





* Capacity class



26,1 t		8,10 m x 7,20 m										360°		ISO	
		(0°)													
11.9 m		11.9 m	16.2 m	20.4 m	24.7 m	29.0 m	33.3 m	37.5 m	40.5 m	45.2 m	50.0 m				
m	t	t	t	t	t	t	t	t	t	t	t	t	m		
	120.0*	-	-	-	-	-	-	-	-	-	-	-			
3	80.0*	74.2*	72.5*	70.6*	58.4	-	-	-	-	-	-	-	3		
4	69.3*	62.7	62.8	60.9	55.1	48.1	-	-	-	-	-	-	4		
5	60.7	53.4	53.9	53.6	51.2	44.5	34.8	-	-	-	-	-	5		
6	53.5	46.3	46.9	46.8	47.2	40.5	32.0	-	-	-	-	-	6		
7	44.8	40.8	41.3	41.9	41.8	36.7	29.6	25.0	-	-	-	-	7		
8	38.4	36.3	36.8	37.5	37.3	34.0	27.6	23.5	20.1	-	-	-	8		
9	-	-	33.6	33.8	33.6	31.4	26.0	22.0	19.0	16.2	-	-	9		
10	-	-	30.5	30.7	30.5	28.8	24.6	20.5	18.0	15.6	12.0	-	10		
12	-	-	23.3	23.5	23.3	22.7	21.8	18.3	16.1	14.3	11.9	-	12		
14	-	-	-	18.6	18.4	18.2	18.4	16.1	14.6	13.0	11.1	-	14		
16	-	-	-	15.3	15.0	15.5	15.0	14.4	13.0	12.0	10.4	-	16		
18	-	-	-	8.8	13.0	13.0	12.5	12.7	11.7	10.9	9.6	-	18		
20	-	-	-	-	11.4	11.1	11.0	10.8	10.6	9.9	8.8	-	20		
22	-	-	-	-	8.8	9.6	9.7	9.3	9.2	9.0	8.1	-	22		
24	-	-	-	-	-	8.7	8.5	8.4	8.0	7.8	7.5	-	24		
26	-	-	-	-	-	6.3	7.5	7.4	7.0	7.1	6.9	-	26		
28	-	-	-	-	-	-	6.7	6.5	6.2	6.3	6.0	-	28		
30	-	-	-	-	-	-	6.1	5.8	5.8	5.5	5.3	-	30		
32	-	-	-	-	-	-	-	5.2	5.3	4.9	4.6	-	32		
34	-	-	-	-	-	-	-	4.4	4.7	4.3	4.1	-	34		
36	-	-	-	-	-	-	-	-	4.2	3.8	3.6	-	36		
38	-	-	-	-	-	-	-	-	3.4	3.4	3.1	-	38		
40	-	-	-	-	-	-	-	-	-	3.0	2.7	-	40		
42	-	-	-	-	-	-	-	-	-	-	2.4	-	42		
44	-	-	-	-	-	-	-	-	-	-	2.1	-	44		



*最大吊上げ荷重クラスを表示(日本仕様)



21.3 t		8.10 m x 7.20 m										360°	ISO
	11.9m	16.2m	20.4m	24.7m	29.0m	33.3m	37.5m	40.5m	45.2m	50.0m			
m	t	t	t	t	t	t	t	t	t	t	m		
3	74.0*	72.5*	70.6*	58.4	-	-	-	-	-	-	3		
4	62.1	62.6	60.9	55.1	48.1	-	-	-	-	-	4		
5	52.9	53.4	53.3	51.2	44.5	34.8	-	-	-	-	5		
6	45.9	46.4	46.3	46.8	40.5	32.0	-	-	-	-	6		
7	40.3	40.9	41.5	41.3	36.7	29.6	25.0	-	-	-	7		
8	35.9	36.6	37.1	36.9	34.0	27.6	23.5	20.1	-	-	8		
9	-	32.9	33.1	32.9	30.9	26.0	22.0	19.0	16.2	-	9		
10	-	27.6	27.9	27.7	27.1	24.6	20.5	18.0	15.6	12.0	10		
12	-	20.7	20.9	20.7	20.4	20.7	18.3	16.1	14.3	11.9	12		
14	-	-	16.5	16.4	16.8	16.2	15.8	14.6	13.0	11.1	14		
16	-	-	13.9	13.9	13.7	13.5	13.4	12.7	12.0	10.4	16		
18	-	-	8.8	11.7	11.5	11.6	11.1	11.1	10.8	9.6	18		
20	-	-	-	10.0	10.1	9.8	9.7	9.4	9.1	8.8	20		
22	-	-	-	8.7	8.7	8.5	8.3	8.0	8.1	7.8	22		
24	-	-	-	-	7.6	7.5	7.3	7.2	7.0	6.8	24		
26	-	-	-	-	6.3	6.6	6.4	6.4	6.1	5.8	26		
28	-	-	-	-	-	5.8	5.6	5.7	5.3	5.0	28		
30	-	-	-	-	-	5.2	4.9	5.0	4.6	4.4	30		
32	-	-	-	-	-	-	4.4	4.4	4.0	3.8	32		
34	-	-	-	-	-	-	3.6	3.9	3.5	3.3	34		
36	-	-	-	-	-	-	-	3.5	3.1	2.8	36		
38	-	-	-	-	-	-	-	2.7	2.7	2.4	38		
40	-	-	-	-	-	-	-	-	2.4	2.1	40		
42	-	-	-	-	-	-	-	-	-	1.8	42		
44	-	-	-	-	-	-	-	-	-	1.5	44		

19.8 t		8.10 m x 7.20 m										360°	ISO
	11.9m	16.2m	20.4m	24.7m	29.0m	33.3m	37.5m	40.5m	45.2m	50.0m			
m	t	t	t	t	t	t	t	t	t	t	m		
3	73.9*	72.5*	70.6*	58.4	-	-	-	-	-	-	3		
4	61.9	62.4	60.9	55.1	48.1	-	-	-	-	-	4		
5	52.7	53.2	53.1	51.2	44.5	34.8	-	-	-	-	5		
6	45.7	46.2	46.2	46.7	40.5	32.0	-	-	-	-	6		
7	40.2	40.8	41.4	41.2	36.7	29.6	25.0	-	-	-	7		
8	35.8	36.6	37.0	36.8	34.0	27.6	23.5	20.1	-	-	8		
9	-	31.7	32.1	31.8	29.8	26.0	22.0	19.0	16.2	-	9		
10	-	26.6	27.0	26.7	26.1	24.6	20.5	18.0	15.6	12.0	10		
12	-	19.9	20.2	19.9	20.4	19.9	18.3	16.1	14.3	11.9	12		
14	-	-	15.9	16.1	16.2	15.6	15.8	14.6	13.0	11.1	14		
16	-	-	13.4	13.4	13.2	13.3	12.9	12.5	12.0	10.4	16		
18	-	-	8.8	11.2	11.3	11.1	11.0	10.6	10.4	9.6	18		
20	-	-	-	9.6	9.7	9.4	9.3	9.0	9.0	8.8	20		
22	-	-	-	8.4	8.3	8.2	8.0	7.9	7.7	7.5	22		
24	-	-	-	-	7.3	7.2	6.9	7.0	6.7	6.4	24		
26	-	-	-	-	6.3	6.3	6.1	6.1	5.8	5.5	26		
28	-	-	-	-	-	5.5	5.3	5.4	5.0	4.7	28		
30	-	-	-	-	-	4.9	4.7	4.7	4.3	4.1	30		
32	-	-	-	-	-	-	4.1	4.2	3.8	3.5	32		
34	-	-	-	-	-	-	3.3	3.7	3.3	3.0	34		
36	-	-	-	-	-	-	-	3.3	2.9	2.6	36		
38	-	-	-	-	-	-	-	2.4	2.5	2.2	38		
40	-	-	-	-	-	-	-	-	2.2	1.9	40		
42	-	-	-	-	-	-	-	-	-	1.6	42		
44	-	-	-	-	-	-	-	-	-	1.3	44		

15.1 t		8.10 m x 7.20 m										360°	ISO
			11.9m	16.2m	20.4m	24.7m	29.0m	33.3m	37.5m	40.5m	45.2m	50.0m	
m	t	t	t	t	t	t	t	t	t	t	t	t	m
3	73.7*	72.5*	70.6*	58.4	-	-	-	-	-	-	-	-	3
4	61.3	61.8	60.9	55.1	48.1	-	-	-	-	-	-	-	4
5	52.2	52.7	52.6	51.2	44.5	34.8	-	-	-	-	-	-	5
6	45.3	45.8	46.0	46.2	40.5	32.0	-	-	-	-	-	-	6
7	39.8	40.3	41.0	39.4	36.1	29.6	25.0	-	-	-	-	-	7
8	32.7	34.3	34.7	33.1	30.5	27.6	23.5	20.1	-	-	-	-	8
9	-	28.0	28.3	28.0	26.2	25.7	22.0	19.0	16.2	-	-	-	9
10	-	23.4	23.7	23.5	22.9	22.5	20.5	18.0	15.6	12.0	-	-	10
12	-	17.4	17.9	18.2	18.0	17.4	17.5	16.0	14.3	11.9	-	-	12
14	-	-	14.3	14.4	14.1	14.3	13.8	13.7	13.0	11.1	-	-	14
16	-	-	11.6	11.7	11.8	11.6	11.4	11.1	10.9	10.4	-	-	16
18	-	-	8.8	9.9	9.8	9.7	9.5	9.6	9.2	9.0	-	-	18
20	-	-	-	8.4	8.3	8.2	8.0	8.1	7.7	7.5	-	-	20
22	-	-	-	7.2	7.2	7.0	6.8	6.9	6.5	6.3	-	-	22
24	-	-	-	-	6.3	6.1	5.9	5.9	5.6	5.3	-	-	24
26	-	-	-	-	5.5	5.3	5.1	5.1	4.8	4.5	-	-	26
28	-	-	-	-	-	4.6	4.4	4.4	4.1	3.8	-	-	28
30	-	-	-	-	-	4.0	3.8	3.9	3.5	3.2	-	-	30
32	-	-	-	-	-	-	3.3	3.4	3.0	2.7	-	-	32
34	-	-	-	-	-	-	-	2.6	2.9	2.3	-	-	34
36	-	-	-	-	-	-	-	-	2.5	1.9	-	-	36
38	-	-	-	-	-	-	-	-	1.8	1.5	-	-	38
40	-	-	-	-	-	-	-	-	-	1.2	-	-	40
42	-	-	-	-	-	-	-	-	-	1.0	-	-	42
44	-	-	-	-	-	-	-	-	-	0.7	-	-	44

10.1 t		8.10 m x 7.20 m										360°	ISO
			11.9m	16.2m	20.4m	24.7m	29.0m	33.3m	37.5m	40.5m	45.2m	50.0m	
m	t	t	t	t	t	t	t	t	t	t	t	t	m
3	73.1*	72.5*	70.6*	58.4	-	-	-	-	-	-	-	-	3
4	60.6	61.1	60.9	55.1	48.1	-	-	-	-	-	-	-	4
5	51.6	52.1	52.1	51.2	44.5	34.8	-	-	-	-	-	-	5
6	44.8	45.3	46.6	41.9	38.0	32.0	-	-	-	-	-	-	6
7	36.2	38.1	36.7	34.1	31.2	29.6	25.0	-	-	-	-	-	7
8	28.0	29.7	30.0	28.6	26.9	25.5	23.4	20.1	-	-	-	-	8
9	-	24.1	24.4	24.1	23.9	22.1	20.7	19.0	16.2	-	-	-	9
10	-	20.1	20.4	21.1	20.8	19.5	18.7	17.1	15.6	12.0	-	-	10
12	-	14.8	15.6	15.7	15.8	15.6	15.3	14.2	13.4	11.9	-	-	12
14	-	-	12.2	12.4	12.4	12.1	12.0	11.8	11.4	10.6	-	-	14
16	-	-	9.8	10.0	10.0	9.9	9.7	9.7	9.4	8.8	-	-	16
18	-	-	8.3	8.3	8.4	8.2	7.9	8.0	7.6	7.3	-	-	18
20	-	-	-	7.0	7.1	6.9	6.6	6.7	6.3	6.0	-	-	20
22	-	-	-	6.0	6.0	5.8	5.6	5.7	5.3	5.0	-	-	22
24	-	-	-	-	5.2	5.0	4.7	4.8	4.4	4.1	-	-	24
26	-	-	-	-	4.5	4.2	4.0	4.1	3.7	3.4	-	-	26
28	-	-	-	-	-	3.6	3.4	3.4	3.0	2.8	-	-	28
30	-	-	-	-	-	3.1	2.8	2.9	2.5	2.2	-	-	30
32	-	-	-	-	-	-	2.4	2.5	2.1	1.8	-	-	32
34	-	-	-	-	-	-	-	1.7	2.1	1.4	-	-	34
36	-	-	-	-	-	-	-	-	1.7	1.1	-	-	36
38	-	-	-	-	-	-	-	-	1.0	0.8	-	-	38
40	-	-	-	-	-	-	-	-	-	0.8	-	-	40

6.9 t		8.10 m x 7.20 m										360°	ISO
			11.9m	16.2m	20.4m	24.7m	29.0m	33.3m	37.5m	40.5m	45.2m	50.0m	
m	t	t	t	t	t	t	t	t	t	t	t	t	m
3	72.6*	72.5*	70.6*	58.4	-	-	-	-	-	-	-	-	3
4	60.2	60.7	60.7	55.1	48.1	-	-	-	-	-	-	-	4
5	51.3	51.8	51.7	48.7	43.4	34.8	-	-	-	-	-	-	5
6	43.2	43.3	41.2	37.9	34.2	31.7	-	-	-	-	-	-	6
7	32.3	34.2	33.2	30.8	28.8	27.1	24.6	-	-	-	-	-	7
8	24.9	26.6	26.9	25.7	25.0	22.9	21.9	20.1	-	-	-	-	8
9	-	21.5	21.9	22.5	21.5	20.5	19.1	17.7	16.2	-	-	-	9
10	-	17.9	18.7	18.9	18.6	18.1	17.2	15.9	14.9	12.0	-	-	10
12	-	13.1	13.9	14.1	14.1	13.8	13.5	13.2	12.2	11.4	-	-	12
14	-	-	10.9	11.0	11.1	10.9	10.6	10.7	9.9	9.2	-	-	14
16	-	-	8.8	8.9	8.9	8.7	8.5	8.6	8.1	7.4	-	-	16
18	-	-	7.2	7.3	7.4	7.1	6.9	7.0	6.6	6.0	-	-	18
20	-	-	-	6.1	6.1	5.9	5.7	5.8	5.4	4.8	-	-	20
22	-	-	-	5.1	5.1	4.9	4.7	4.8	4.3	3.9	-	-	22
24	-	-	-	-	4.3	4.1	3.8	3.9	3.5	3.2	-	-	24
26	-	-	-	-	3.7	3.4	3.2	3.3	2.9	2.6	-	-	26
28	-	-	-	-	-	2.9	2.6	2.7	2.3	2.0	-	-	28
30	-	-	-	-	-	2.4	2.2	2.2	1.8	1.6	-	-	30
32	-	-	-	-	-	-	1.8	1.8	1.4	1.2	-	-	32
34	-	-	-	-	-	-	1.1	1.5	1.1	0.8	-	-	34
36	-	-	-	-	-	-	-	1.2	0.8	-	-	-	36

5.4 t		8.10 m x 7.20 m										360°	ISO
			11.9m	16.2m	20.4m	24.7m	29.0m	33.3m	37.5m	40.5m	45.2m	50.0m	
m	t	t	t	t	t	t	t	t	t	t	t	t	m
3	72.3*	72.5*	70.6*	58.4	-	-	-	-	-	-	-	-	3
4	60.0	60.5	60.5	55.1	48.1	-	-	-	-	-	-	-	4
5	51.1	51.6	50.3	46.3	41.2	34.8	-	-	-	-	-	-	5
6	42.2	42.1	39.2	36.0	32.4	31.0	-	-	-	-	-	-	6
7	30.5	32.4	31.5	29.2	28.1	25.6	23.7	-	-	-	-	-	7
8	23.5	25.1	25.5	24.9	23.7	21.9	20.8	18.9	-	-	-	-	8
9	-	20.3	21.2	21.4	20.4	19.6	18.5	17.1	16.0	-	-	-	9
10	-	16.9	17.7	17.9	18.0	17.1	16.2	14.9	14.6	12.0	-	-	10
12	-	12.3	13.1	13.3	13.3	13.2	12.7	12.5	11.5	10.6	-	-	12
14	-	-	10.3	10.4	10.4	10.2	10.0	10.0	9.1	8.4	-	-	14
16	-	-	8.2	8.3	8.4	8.2	7.9	8.0	7.4	6.8	-	-	16
18	-	-	6.7	6.8	6.8	6.6	6.4	6.5	6.0	5.4	-	-	18
20	-	-	-	5.6	5.7	5.4	5.2	5.3	4.8	4.3	-	-	20
22	-	-	-	4.7	4.7	4.5	4.2	4.3	3.9	3.4	-	-	22
24	-	-	-	-	4.0	3.7	3.4	3.5	3.1	2.7	-	-	24
26	-	-	-	-	3.3	3.1	2.8	2.9	2.5	2.2	-	-	26
28	-	-	-	-	-	2.6	2.3	2.4	2.0	1.7	-	-	28
30	-	-	-	-	-	2.1	1.9	1.9	1.5	1.3	-	-	30
32	-	-	-	-	-	-	1.5	1.5	1.1	0.9	-	-	32
34	-	-	-	-	-	-	0.9	1.2	0.8	-	-	-	34
36	-	-	-	-	-	-	-	0.9	-	-	-	-	36

4.7 t		8.10 m x 7.20 m										360°	ISO
	11.9m	16.2m	20.4m	24.7m	29.0m	33.3m	37.5m	40.5m	45.2m	50.0m			
m	t	t	t	t	t	t	t	t	t	t	m		
3	72.2*	72.5*	70.6*	58.4	-	-	-	-	-	-	3		
4	59.9	60.4	60.4	55.1	48.1	-	-	-	-	-	4		
5	51.0	51.5	50.0	45.1	40.2	34.8	-	-	-	-	5		
6	41.1	41.0	38.2	35.1	31.9	30.3	-	-	-	-	6		
7	29.6	31.5	30.7	28.4	27.4	25.0	23.2	-	-	-	7		
8	22.8	24.4	24.8	24.4	23.1	21.8	20.3	18.6	-	-	8		
9	-	19.7	20.7	20.8	19.8	19.1	18.0	16.6	15.5	-	9		
10	-	16.4	17.2	17.4	17.5	16.6	15.7	14.9	14.1	12.0	10		
12	-	12.0	12.7	12.9	12.9	12.8	12.3	12.1	11.0	10.2	12		
14	-	-	9.9	10.0	10.1	9.9	9.6	9.7	8.8	8.1	14		
16	-	-	7.9	8.0	8.1	7.9	7.6	7.7	7.1	6.5	16		
18	-	-	6.4	6.5	6.6	6.4	6.1	6.2	5.7	5.1	18		
20	-	-	-	5.4	5.4	5.2	4.9	5.0	4.6	4.0	20		
22	-	-	-	4.5	4.5	4.3	4.0	4.1	3.7	3.2	22		
24	-	-	-	-	3.8	3.5	3.3	3.3	2.9	2.5	24		
26	-	-	-	-	3.1	2.9	2.6	2.7	2.3	2.0	26		
28	-	-	-	-	-	2.4	2.1	2.2	1.8	1.5	28		
30	-	-	-	-	-	2.0	1.7	1.8	1.4	1.1	30		
32	-	-	-	-	-	-	1.3	1.4	1.0	0.7	32		
34	-	-	-	-	-	-	0.7	1.1	-	-	34		
36	-	-	-	-	-	-	-	0.8	-	-	36		

0.0 t		8.10 m x 7.20 m										360°	ISO
	11.9m	16.2m	20.4m	24.7m	29.0m	33.3m	37.5m	40.5m	45.2m	50.0m			
m	t	t	t	t	t	t	t	t	t	t	m		
3	71.5*	72.0*	70.6*	58.4	-	-	-	-	-	-	3		
4	59.3	59.8	57.5	52.1	45.0	-	-	-	-	-	4		
5	48.9	45.8	41.8	37.7	34.4	31.5	-	-	-	-	5		
6	33.6	34.1	31.8	29.7	27.8	25.4	-	-	-	-	6		
7	24.0	25.9	25.5	24.5	22.9	21.6	20.2	18.2	-	-	7		
8	18.3	19.9	21.0	20.5	19.5	18.1	17.0	16.5	-	-	8		
9	14.5	16.0	16.9	17.2	16.6	15.3	14.4	14.0	12.6	-	9		
10	-	13.2	14.2	14.3	14.2	13.1	12.3	12.0	10.8	9.9	10		
12	-	9.3	10.2	10.3	10.3	9.9	9.3	9.2	8.2	7.4	12		
14	-	-	7.7	7.8	7.7	7.5	7.2	7.2	6.3	5.7	14		
16	-	-	6.0	6.0	6.0	5.8	5.6	5.7	4.9	4.2	16		
18	-	-	4.7	4.8	4.8	4.5	4.4	4.4	3.7	3.1	18		
20	-	-	-	3.8	3.8	3.5	3.4	3.5	2.8	2.3	20		
22	-	-	-	3.1	3.0	2.7	2.6	2.7	2.2	1.7	22		
24	-	-	-	-	2.4	2.1	2.0	2.1	1.6	1.1	24		
26	-	-	-	-	1.9	1.6	1.5	1.6	1.2	-	26		
28	-	-	-	-	-	1.2	1.1	1.1	0.7	-	28		
30	-	-	-	-	-	0.9	0.7	0.8	-	-	30		

アウトリガ中間張出

26.1 t		8.10 m x 6.00 m										360°		ISO	
		11.9m	16.2m	20.4m	24.7m	29.0m	33.3m	37.5m	40.5m	45.2m	50.0m				
m	t	t	t	t	t	t	t	t	t	t	t	m	t		
3	71.3*	71.8*	70.6*	58.4	-	-	-	-	-	-	-	3	-		
4	59.6	60.1	60.0	55.1	48.1	-	-	-	-	-	-	4	-		
5	51.0	51.5	51.4	51.2	44.5	34.8	-	-	-	-	-	5	-		
6	44.3	44.8	45.4	45.2	40.5	32.0	-	-	-	-	-	6	-		
7	38.8	39.4	40.0	39.8	36.7	29.6	25.0	18.2	-	-	-	7	-		
8	33.6	35.1	35.4	35.1	33.6	27.6	23.5	20.1	-	-	-	8	-		
9	23.8	28.7	29.0	28.7	28.2	26.0	22.0	19.0	16.2	-	-	9	-		
10	-	24.1	24.4	24.2	23.6	24.2	20.5	18.0	15.6	12.0	-	10	-		
12	-	18.1	18.3	18.5	18.6	18.1	17.8	16.1	14.3	11.9	-	12	-		
14	-	-	14.8	14.9	14.7	14.8	14.4	13.8	13.0	11.1	-	14	-		
16	-	-	12.2	12.2	12.3	12.1	12.0	11.7	11.4	10.4	-	16	-		
18	-	-	8.8	10.2	10.3	10.1	10.0	9.7	9.8	9.5	-	18	-		
20	-	-	-	8.8	8.8	8.6	8.5	8.6	8.3	8.0	-	20	-		
22	-	-	-	-	7.6	7.4	7.3	7.4	7.1	6.9	-	22	-		
24	-	-	-	-	6.7	6.5	6.4	6.4	6.1	5.9	-	24	-		
26	-	-	-	-	5.9	5.7	5.6	5.6	5.3	5.1	-	26	-		
28	-	-	-	-	-	5.0	4.9	5.0	4.7	4.5	-	28	-		
30	-	-	-	-	-	4.5	4.3	4.4	4.1	3.9	-	30	-		
32	-	-	-	-	-	-	3.9	3.9	3.6	3.4	-	32	-		
34	-	-	-	-	-	-	3.5	3.5	3.2	3.0	-	34	-		
36	-	-	-	-	-	-	-	3.1	2.8	2.6	-	36	-		
38	-	-	-	-	-	-	-	2.5	2.5	2.3	-	38	-		
40	-	-	-	-	-	-	-	-	2.2	2.0	-	40	-		
42	-	-	-	-	-	-	-	-	2.0	1.7	-	42	-		
44	-	-	-	-	-	-	-	-	-	1.4	-	44	-		
46	-	-	-	-	-	-	-	-	-	1.2	-	46	-		

21.3 t		8.10 m x 6.00 m										360°		ISO	
		11.9m	16.2m	20.4m	24.7m	29.0m	33.3m	37.5m	40.5m	45.2m	50.0m				
m	t	t	t	t	t	t	t	t	t	t	t	m	t		
3	70.7*	71.2*	70.6*	58.4	-	-	-	-	-	-	-	3	-		
4	59.2	59.6	59.6	55.1	48.1	-	-	-	-	-	-	4	-		
5	50.6	51.1	51.0	51.2	44.5	34.8	-	-	-	-	-	5	-		
6	43.7	44.2	44.8	44.7	40.5	32.0	-	-	-	-	-	6	-		
7	37.8	39.3	39.5	38.4	34.6	29.6	25.0	18.2	-	-	-	7	-		
8	29.5	31.0	31.3	31.0	29.4	27.6	23.5	20.1	-	-	-	8	-		
9	23.8	25.3	25.6	25.3	24.9	24.7	22.0	19.0	16.2	-	-	9	-		
10	-	21.2	21.5	21.7	21.8	21.3	19.8	18.0	15.6	12.0	-	10	-		
12	-	15.8	16.5	16.6	16.3	16.5	16.0	15.3	14.3	11.9	-	12	-		
14	-	-	13.0	13.1	13.2	13.0	12.8	12.5	12.2	11.1	-	14	-		
16	-	-	10.6	10.8	10.7	10.5	10.4	10.4	10.2	9.9	-	16	-		
18	-	-	8.8	9.0	9.0	8.8	8.7	8.7	8.4	8.2	-	18	-		
20	-	-	-	7.6	7.6	7.4	7.3	7.4	7.1	6.8	-	20	-		
22	-	-	-	6.6	6.5	6.3	6.2	6.3	6.0	5.8	-	22	-		
24	-	-	-	-	5.7	5.5	5.4	5.4	5.1	4.9	-	24	-		
26	-	-	-	-	5.0	4.8	4.7	4.7	4.4	4.2	-	26	-		
28	-	-	-	-	-	4.2	4.1	4.1	3.8	3.6	-	28	-		
30	-	-	-	-	-	3.7	3.6	3.6	3.3	3.1	-	30	-		
32	-	-	-	-	-	-	3.2	3.2	2.9	2.7	-	32	-		
34	-	-	-	-	-	-	2.8	2.8	2.5	2.3	-	34	-		
36	-	-	-	-	-	-	-	2.5	2.2	2.0	-	36	-		
38	-	-	-	-	-	-	-	-	1.9	1.7	-	38	-		
40	-	-	-	-	-	-	-	-	1.6	1.4	-	40	-		
42	-	-	-	-	-	-	-	-	1.4	1.1	-	42	-		
44	-	-	-	-	-	-	-	-	-	0.8	-	44	-		

アウトリガ中間張出

19.8t		8.10 m x 6.00 m										360°	ISO
	11.9m	16.2m	20.4m	24.7m	29.0m	33.3m	37.5m	40.5m	45.2m	50.0m			
m	t	t	t	t	t	t	t	t	t	t	m		
3	70.6*	70.6*	70.6*	58.4	-	-	-	-	-	-	3		
4	59.0	59.5	59.4	55.1	48.1	-	-	-	-	-	4		
5	50.4	50.9	50.8	51.2	44.5	34.8	-	-	-	-	5		
6	43.5	44.0	44.7	44.5	40.1	32.0	-	-	-	-	6		
7	36.3	38.0	38.4	36.9	33.2	29.6	25.0	18.2	-	-	7		
8	28.3	29.8	30.1	29.8	28.2	27.2	23.5	20.1	-	-	8		
9	-	24.3	24.6	24.3	24.9	23.7	21.5	19.0	16.2	-	9		
10	-	20.4	20.6	21.1	21.0	20.4	19.5	18.0	15.6	12.0	10		
12	-	15.1	15.8	15.9	15.9	15.8	15.4	15.1	14.3	11.9	12		
14	-	-	12.4	12.5	12.6	12.4	12.3	11.9	12.0	11.1	14		
16	-	-	10.1	10.3	10.3	10.1	10.0	10.0	9.7	9.5	16		
18	-	-	8.5	8.6	8.6	8.4	8.3	8.3	8.0	7.8	18		
20	-	-	-	7.3	7.3	7.1	6.9	7.0	6.7	6.5	20		
22	-	-	-	6.3	6.2	6.0	5.9	6.0	5.7	5.5	22		
24	-	-	-	-	5.4	5.2	5.1	5.2	4.9	4.6	24		
26	-	-	-	-	4.8	4.5	4.4	4.5	4.2	4.0	26		
28	-	-	-	-	-	4.0	3.8	3.9	3.6	3.4	28		
30	-	-	-	-	-	3.5	3.4	3.4	3.1	2.9	30		
32	-	-	-	-	-	-	3.0	3.0	2.7	2.5	32		
34	-	-	-	-	-	-	2.6	2.6	2.3	2.1	34		
36	-	-	-	-	-	-	-	2.3	2.0	1.8	36		
38	-	-	-	-	-	-	-	1.7	1.7	1.5	38		
40	-	-	-	-	-	-	-	-	1.5	1.2	40		
42	-	-	-	-	-	-	-	-	1.2	0.9	42		

15.1t		8.10 m x 6.00 m										360°	ISO
	11.9m	16.2m	20.4m	24.7m	29.0m	33.3m	37.5m	40.5m	45.2m	50.0m			
m	t	t	t	t	t	t	t	t	t	t	m		
3	70.1*	70.5*	70.5*	58.4	-	-	-	-	-	-	3		
4	58.6	59.1	59.0	55.1	48.1	-	-	-	-	-	4		
5	49.7	50.2	50.3	49.6	43.4	34.8	-	-	-	-	5		
6	42.9	43.5	43.4	39.1	34.6	31.6	-	-	-	-	6		
7	31.4	33.1	33.5	32.0	29.1	27.4	24.7	18.2	-	-	7		
8	24.4	25.8	26.2	25.9	25.9	23.4	21.9	20.1	-	-	8		
9	-	21.0	21.8	21.9	21.7	20.6	19.5	17.7	16.2	-	9		
10	-	17.5	18.3	18.4	18.2	18.3	17.3	16.3	15.2	12.0	10		
12	-	13.0	13.6	13.8	13.8	13.6	13.5	13.2	12.7	11.8	12		
14	-	-	10.8	10.9	10.9	10.6	10.5	10.6	10.2	9.7	14		
16	-	-	8.7	8.8	8.9	8.6	8.4	8.5	8.2	8.0	16		
18	-	-	7.2	7.3	7.3	7.1	6.9	7.0	6.7	6.5	18		
20	-	-	-	6.1	6.2	5.9	5.8	5.9	5.5	5.3	20		
22	-	-	-	5.2	5.3	5.0	4.9	5.0	4.6	4.4	22		
24	-	-	-	-	4.5	4.3	4.2	4.2	3.9	3.7	24		
26	-	-	-	-	3.9	3.7	3.6	3.6	3.3	3.1	26		
28	-	-	-	-	-	3.2	3.1	3.1	2.8	2.6	28		
30	-	-	-	-	-	2.8	2.6	2.7	2.4	2.2	30		
32	-	-	-	-	-	-	2.3	2.3	2.0	1.8	32		
34	-	-	-	-	-	-	2.0	2.0	1.7	1.4	34		
36	-	-	-	-	-	-	-	1.7	1.4	1.1	36		
38	-	-	-	-	-	-	-	1.0	1.1	0.8	38		
40	-	-	-	-	-	-	-	-	0.8	-	40		



メインブーム



アウトリガ中間張出

10.1t		8.10 m x 6.00 m										360°	ISO
	11.9m	16.2m	20.4m	24.7m	29.0m	33.3m	37.5m	40.5m	45.2m	50.0m			
m	t	t	t	t	t	t	t	t	t	t	m		
3	69.5*	70.0*	69.9*	58.4	-	-	-	-	-	-	3		
4	57.9	58.4	58.3	54.5	48.1	-	-	-	-	-	4		
5	49.0	49.5	47.7	42.0	36.5	34.0	-	-	-	-	5		
6	36.4	38.4	36.7	32.9	31.1	27.6	-	-	-	-	6		
7	26.3	28.0	28.4	27.6	25.7	23.6	21.7	18.2	-	-	7		
8	20.3	21.8	22.6	22.8	21.8	20.6	19.2	17.5	-	-	8		
9	16.3	17.6	18.4	18.5	18.7	17.8	16.7	15.9	14.7	-	9		
10	-	14.6	15.4	15.5	15.6	15.4	14.7	14.3	13.0	12.0	10		
12	-	10.7	11.5	11.4	11.6	11.3	11.2	11.3	10.3	9.5	12		
14	-	-	8.9	8.9	9.0	8.8	8.6	8.7	8.3	7.6	14		
16	-	-	7.1	7.1	7.2	7.0	6.9	7.0	6.6	6.2	16		
18	-	-	5.9	5.8	5.9	5.7	5.6	5.7	5.3	5.1	18		
20	-	-	-	4.8	4.9	4.7	4.6	4.7	4.3	4.1	20		
22	-	-	-	-	4.1	3.9	3.8	3.9	3.6	3.4	22		
24	-	-	-	-	3.5	3.3	3.2	3.3	2.9	2.7	24		
26	-	-	-	-	3.0	2.8	2.7	2.7	2.4	2.2	26		
28	-	-	-	-	-	2.4	2.2	2.3	2.0	1.8	28		
30	-	-	-	-	-	2.0	1.9	1.9	1.6	1.3	30		
32	-	-	-	-	-	-	1.5	1.6	1.2	1.0	32		
34	-	-	-	-	-	-	0.9	1.3	0.9	-	34		
36	-	-	-	-	-	-	-	1.0	-	-	36		

6.9t		8.10 m x 6.00 m										360°	ISO
	11.9m	16.2m	20.4m	24.7m	29.0m	33.3m	37.5m	40.5m	45.2m	50.0m			
m	t	t	t	t	t	t	t	t	t	t	m		
3	69.2*	69.7*	69.6*	58.4	-	-	-	-	-	-	3		
4	57.3	57.9	56.6	50.3	42.4	-	-	-	-	-	4		
5	48.2	46.8	42.1	37.0	34.3	29.9	-	-	-	-	5		
6	31.9	33.9	32.3	29.7	27.3	25.4	-	-	-	-	6		
7	22.9	24.6	25.5	24.7	22.9	21.1	19.6	18.2	-	-	7		
8	17.6	19.1	19.9	20.1	19.5	17.9	16.7	16.2	-	-	8		
9	14.1	15.3	16.2	16.4	16.4	15.5	14.4	14.0	12.7	-	9		
10	-	12.7	13.6	13.7	13.7	13.5	12.6	12.3	11.1	10.1	10		
12	-	9.2	10.0	10.1	10.1	9.8	9.7	9.7	8.7	7.9	12		
14	-	-	7.7	7.8	7.8	7.5	7.4	7.5	7.0	6.3	14		
16	-	-	6.1	6.2	6.2	6.0	5.8	5.9	5.6	5.0	16		
18	-	-	5.0	5.0	5.0	4.8	4.7	4.8	4.4	4.0	18		
20	-	-	-	4.1	4.1	3.9	3.8	3.9	3.6	3.2	20		
22	-	-	-	3.5	3.4	3.2	3.1	3.2	2.9	2.6	22		
24	-	-	-	-	2.9	2.7	2.5	2.6	2.3	2.0	24		
26	-	-	-	-	2.4	2.2	2.1	2.1	1.8	1.5	26		
28	-	-	-	-	-	1.8	1.7	1.8	1.4	1.1	28		
30	-	-	-	-	-	1.5	1.3	1.4	1.0	0.7	30		
32	-	-	-	-	-	-	1.0	1.0	-	-	32		
34	-	-	-	-	-	-	0.7	0.8	-	-	34		

アウトリガ中間張出

4.7 t		8.10 m x 6.00 m										360°		ISO	
		11.9m	16.2m	20.4m	24.7m	29.0m	33.3m	37.5m	40.5m	45.2m	50.0m				
m	t	t	t	t	t	t	t	t	t	t	t	m	m		
3	69.0*	69.4*	69.4*	58.4	-	-	-	-	-	-	-	3	3		
4	57.0	57.6	53.8	45.8	38.8	-	-	-	-	-	-	4	4		
5	45.1	43.0	38.2	33.6	31.2	27.6	-	-	-	-	-	5	5		
6	28.8	30.8	29.2	27.5	25.2	23.0	-	-	-	-	-	6	6		
7	20.6	22.3	23.3	22.4	20.9	19.1	17.6	17.0	-	-	-	7	7		
8	15.7	17.2	18.1	18.4	17.6	16.2	15.0	14.5	-	-	-	8	8		
9	12.5	13.8	14.8	14.9	14.9	13.9	12.9	12.6	11.3	-	-	9	9		
10	-	11.4	12.3	12.4	12.4	12.1	11.3	11.0	9.8	8.9	-	10	10		
12	-	8.2	9.0	9.1	9.0	8.8	8.7	8.6	7.6	6.9	-	12	12		
14	-	-	6.8	6.9	6.9	6.7	6.6	6.7	6.0	5.4	-	14	14		
16	-	-	5.4	5.5	5.4	5.2	5.1	5.2	4.8	4.2	-	16	16		
18	-	-	4.4	4.4	4.4	4.2	4.1	4.1	3.8	3.3	-	18	18		
20	-	-	-	3.6	3.6	3.4	3.3	3.3	3.0	2.6	-	20	20		
22	-	-	-	3.0	2.9	2.7	2.6	2.7	2.4	1.9	-	22	22		
24	-	-	-	-	2.4	2.2	2.1	2.2	1.9	1.4	-	24	24		
26	-	-	-	-	2.0	1.8	1.7	1.7	1.4	0.9	-	26	26		
28	-	-	-	-	-	1.4	1.3	1.3	0.9	-	-	28	28		
30	-	-	-	-	-	1.1	0.9	1.0	-	-	-	30	30		

0.0t		8.10 m x 6.00 m										360°		ISO	
		11.9m	16.2m	20.4m	24.7m	29.0m	33.3m	37.5m	40.5m	45.2m	50.0m				
m	t	t	t	t	t	t	t	t	t	t	t	m	m		
3	68.3*	68.8*	66.7*	55.4	-	-	-	-	-	-	-	3	3		
4	56.3	50.1	42.7	37.2	32.7	-	-	-	-	-	-	4	4		
5	35.4	33.8	31.1	27.8	25.2	22.4	-	-	-	-	-	5	5		
6	22.3	24.3	23.7	21.6	19.9	17.9	-	-	-	-	-	6	6		
7	15.7	17.4	18.4	17.4	16.3	14.7	13.5	13.0	-	-	-	7	7		
8	11.8	13.3	14.4	14.4	13.6	12.3	11.4	11.0	-	-	-	8	8		
9	9.3	10.5	11.5	11.6	11.6	10.5	9.7	9.4	8.2	-	-	9	9		
10	-	8.6	9.5	9.6	9.6	9.0	8.3	8.1	7.1	6.3	-	10	10		
12	-	6.0	6.8	6.9	6.9	6.6	6.3	6.2	5.3	4.6	-	12	12		
14	-	-	5.1	5.2	5.1	4.9	4.8	4.8	4.0	3.4	-	14	14		
16	-	-	3.9	4.0	3.9	3.7	3.6	3.7	3.0	2.5	-	16	16		
18	-	-	3.1	3.1	3.1	2.9	2.8	2.8	2.2	1.7	-	18	18		
20	-	-	-	2.4	2.4	2.2	2.1	2.2	1.6	1.1	-	20	20		
22	-	-	-	1.9	1.9	1.7	1.6	1.7	1.1	-	-	22	22		
24	-	-	-	-	1.5	1.2	1.1	1.2	-	-	-	24	24		
26	-	-	-	-	1.1	0.8	-	0.7	-	-	-	26	26		

油圧オフセット式補助ジブ 作業範囲図

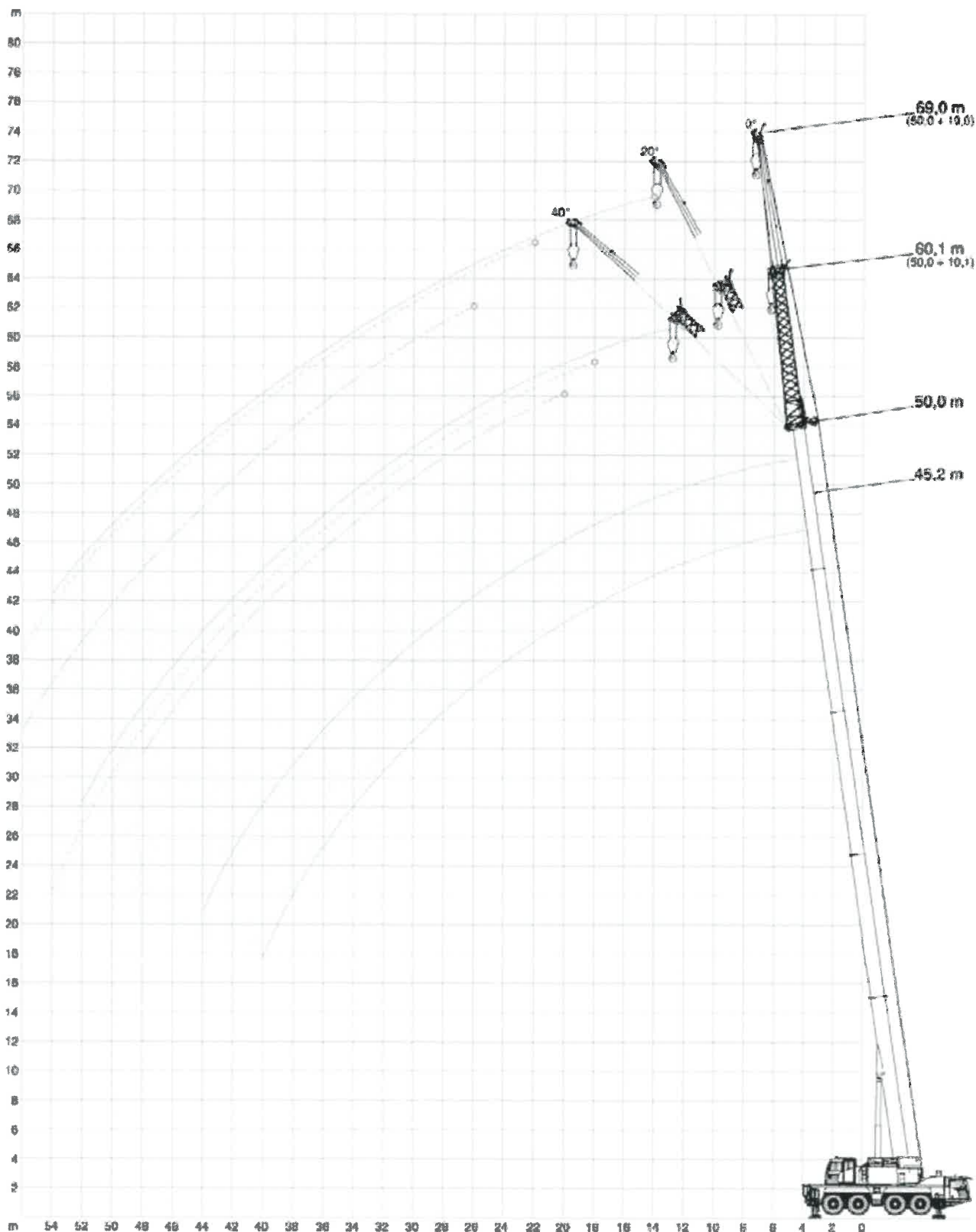

* ジブ作業時の吊上荷重は1条掛けの場合ジブ強度上20%減トンされますのでご注意ください。

26.1 t		8.10 m x 7.20 m		360°		ISO	
50.0 m							
		10.1 m			19.0 m		
		0°	20°	40°	0°	20°	40°
m	t	t	t	t	t	t	
12	6.5	-	-	-	-	-	
14	6.5	-	-	3.5	-	-	
16	6.5	6.5	-	3.5	-	-	
18	6.5	6.5	-	3.5	-	-	
20	6.4	6.2	5.8	3.5	3.3	-	
22	6.0	5.9	5.5	3.5	3.2	-	
24	5.7	5.6	5.3	3.4	3.2	-	
26	5.3	5.3	5.1	3.3	3.1	3.1	
28	5.0	5.0	4.9	3.3	3.0	3.0	
30	4.7	4.7	4.7	3.2	3.0	3.0	
32	4.1	4.4	4.4	3.2	2.9	2.9	
34	3.5	3.9	4.1	3.0	2.9	2.8	
36	3.0	3.3	3.5	2.9	2.8	2.8	
38	2.6	2.9	3.0	2.8	2.7	2.7	
40	2.2	2.4	2.6	2.4	2.5	2.6	
42	1.9	2.1	2.2	2.0	2.1	2.5	
44	1.5	1.7	1.8	1.7	1.8	2.4	
46	1.3	1.4	1.5	1.4	1.5	2.1	
48	1.0	1.1	1.2	1.2	1.2	1.7	
50	0.8	0.9	-	0.9	1.0	1.4	
52	-	-	-	0.7	0.7	1.1	
54	-	-	-	-	-	0.9	

45.2 m							
		10.1 m			19.0 m		
		0°	20°	40°	0°	20°	40°
m	t	t	t	t	t	t	
12	8.0	-	-	4.2	-	-	
14	7.7	7.4	-	4.2	-	-	
16	7.5	7.1	-	4.1	-	-	
18	7.2	6.7	6.2	4.0	-	-	
20	6.7	6.3	5.9	3.9	3.6	-	
22	6.2	5.9	5.6	3.8	3.5	-	
24	5.7	5.6	5.3	3.7	3.4	3.2	
26	5.4	5.3	5.1	3.6	3.3	3.2	
28	5.0	4.9	4.9	3.5	3.3	3.1	
30	4.7	4.6	4.6	3.4	3.2	3.1	
32	4.3	4.3	4.3	3.3	3.1	3.0	
34	3.9	4.0	4.0	3.1	3.0	3.0	
36	3.4	3.6	3.7	3.0	2.9	2.9	
38	2.9	3.2	3.3	2.9	2.8	2.9	
40	2.5	2.7	2.9	2.7	2.7	2.9	
42	2.2	2.4	2.4	2.4	2.6	2.8	
44	1.9	2.0	2.1	2.1	2.4	2.5	
46	1.6	1.7	-	1.8	2.1	2.3	
48	1.3	1.4	-	1.5	1.8	2.0	
50	1.1	1.2	-	1.3	1.5	1.7	
52	-	-	-	1.0	1.3	1.4	
54	-	-	-	0.8	1.0	-	
56	-	-	-	-	0.8	-	

41.8 m							
		10.1 m			19.0 m		
		0°	20°	40°	0°	20°	40°
m	t	t	t	t	t	t	
9	10.2	-	-	-	-	-	
10	10.1	-	-	5.1	-	-	
12	9.7	-	-	5.0	-	-	
14	9.4	8.3	-	4.8	-	-	
16	9.0	8.0	7.3	4.7	-	-	
18	8.5	7.7	7.1	4.5	4.1	-	
20	8.0	7.4	6.9	4.4	3.9	-	
22	7.5	7.1	6.8	4.2	3.8	3.5	
24	7.0	6.9	6.6	4.1	3.7	3.4	
26	6.3	6.5	6.5	3.9	3.6	3.3	
28	5.4	5.8	6.1	3.8	3.5	3.2	
30	4.7	5.0	5.3	3.7	3.4	3.2	
32	4.0	4.3	4.6	3.6	3.3	3.1	
34	3.4	3.7	3.9	3.5	3.2	3.1	
36	2.9	3.2	3.4	3.3	3.1	3.0	
38	2.5	2.7	2.9	2.8	3.1	3.0	
40	2.1	2.3	2.4	2.4	2.9	3.0	
42	1.8	1.9	-	2.1	2.5	2.7	
44	1.5	1.6	-	1.7	2.1	2.3	
46	1.2	1.3	-	1.4	1.8	2.0	
48	-	-	-	1.2	1.5	1.6	
50	-	-	-	1.0	1.2	1.3	
52	-	-	-	0.8	0.9	-	
54	-	-	-	-	-	-	

11.9 m							
		10.1 m			19.0 m		
		0°	20°	40°	0°	20°	40°
m	t	t	t	t	t	t	
3	13.4	-	-	8.0	-	-	
4	13.4	-	-	7.9	-	-	
5	13.4	12.6	-	7.7	-	-	
6	13.4	11.8	-	7.6	-	-	
7	13.2	11.1	-	7.3	-	-	
8	12.6	10.6	8.9	7.1	-	-	
9	12.0	10.0	8.6	6.8	-	-	
10	11.4	9.5	8.3	6.5	5.7	-	
12	10.2	8.7	7.9	6.0	5.2	-	
14	9.2	8.1	7.5	5.5	4.9	4.3	
16	8.4	7.6	7.4	5.0	4.5	4.1	
18	7.7	7.4	-	4.7	4.2	3.9	
20	-	-	-	4.4	3.9	3.7	
22	-	-	-	4.1	3.8	3.6	
24	-	-	-	3.8	3.6	3.5	
26	-	-	-	3.6	3.5	-	

油圧オフセット式補助ジブ

21.3 t 8.10 m x 7.20 m 360° ISO

 50.0 m

m	10.1 m			19.0 m		
	0°	20°	40°	0°	20°	40°
12	6.5	-	-	-	-	-
14	6.5	-	-	3.5	-	-
16	6.5	6.5	-	3.5	-	-
18	6.5	6.5	-	3.5	-	-
20	6.4	6.2	5.8	3.5	-	-
22	6.0	5.9	5.5	3.5	3.3	-
24	5.7	5.6	5.3	3.4	3.2	-
26	5.3	5.3	5.1	3.3	3.2	3.1
28	4.5	5.0	4.9	3.3	3.1	3.0
30	3.8	4.2	4.6	3.2	3.0	3.0
32	3.3	3.6	3.9	3.2	3.0	2.9
34	2.7	3.1	3.3	2.9	2.9	2.8
36	2.3	2.6	2.8	2.4	2.9	2.8
38	1.9	2.2	2.3	2.1	2.6	2.7
40	1.5	1.8	1.9	1.7	2.2	2.6
42	1.2	1.4	1.6	1.4	1.8	2.2
44	0.9	1.1	1.2	1.1	1.5	1.8
46	-	0.8	0.9	0.8	1.2	1.5
48	-	-	-	-	0.9	1.2
50	-	-	-	-	-	0.9

 45.2 m

m	10.1 m			19.0 m		
	0°	20°	40°	0°	20°	40°
12	8.0	-	-	4.2	-	-
14	7.7	7.4	-	4.2	-	-
16	7.5	7.1	-	4.1	-	-
18	7.2	6.7	6.2	4.0	-	-
20	6.7	6.3	5.9	3.9	3.6	-
22	6.2	5.9	5.6	3.8	3.5	-
24	5.7	5.6	5.3	3.7	3.4	3.2
26	5.4	5.3	5.1	3.6	3.3	3.2
28	4.9	4.9	4.9	3.5	3.3	3.1
30	4.2	4.6	4.6	3.4	3.2	3.0
32	3.6	3.9	4.1	3.3	3.1	3.0
34	3.1	3.4	3.6	3.1	3.0	2.9
36	2.6	2.9	3.0	2.8	2.9	2.8
38	2.2	2.5	2.6	2.4	2.8	2.7
40	1.9	2.1	2.2	2.1	2.5	2.6
42	1.6	1.7	1.8	1.7	2.1	2.4
44	1.3	1.4	1.5	1.4	1.8	2.1
46	1.0	1.1	-	1.2	1.5	1.7
48	0.8	0.9	-	0.9	1.2	1.4
50	-	-	-	0.7	1.0	1.1
52	-	-	-	-	0.8	0.9

 41.8 m

m	10.1 m			19.0 m		
	0°	20°	40°	0°	20°	40°
9	10.2	-	-	-	-	-
10	10.1	-	-	5.1	-	-
12	9.7	-	-	5.0	-	-
14	9.4	8.3	-	4.8	-	-
16	9.0	8.0	7.3	4.7	-	-
18	8.5	7.7	7.1	4.5	4.1	-
20	8.0	7.4	6.9	4.4	3.9	-
22	7.3	7.1	6.8	4.2	3.8	3.5
24	6.2	6.7	6.6	4.1	3.7	3.4
26	5.2	5.7	6.1	3.9	3.6	3.3
28	4.4	4.9	5.2	3.8	3.5	3.2
30	3.7	4.1	4.4	3.7	3.4	3.2
32	3.2	3.5	3.7	3.5	3.3	3.1
34	2.6	2.9	3.1	3.0	3.2	3.1
36	2.2	2.5	2.6	2.5	3.1	3.0
38	1.8	2.0	1.7	2.1	2.6	3.0
40	1.4	1.6	-	1.7	2.2	2.5
42	1.1	1.3	-	1.4	1.8	2.1
44	0.9	1.0	-	1.1	1.5	1.7
46	-	0.7	-	0.9	1.2	1.4
48	-	-	-	-	0.9	1.1
50	-	-	-	-	-	0.8
52	-	-	-	-	-	-

 11.9 m

m	10.1 m			19.0 m		
	0°	20°	40°	0°	20°	40°
3	13.4	-	-	8.0	-	-
4	13.4	-	-	7.9	-	-
5	13.4	12.6	-	7.7	-	-
6	13.4	11.8	-	7.6	-	-
7	13.2	11.1	-	7.3	-	-
8	12.6	10.6	8.9	7.1	-	-
9	12.0	10.0	8.6	6.8	-	-
10	11.4	9.5	8.3	6.5	5.7	-
12	10.2	8.7	7.9	6.0	5.2	-
14	9.2	8.1	7.5	5.5	4.9	4.3
16	8.4	7.6	7.4	5.0	4.5	4.1
18	7.7	7.4	-	4.7	4.2	3.9
20	-	-	-	4.4	3.9	3.7
22	-	-	-	4.1	3.8	3.6
24	-	-	-	3.8	3.6	3.5
26	-	-	-	3.6	3.5	-

10.1 t		8.10 m x 7.20 m		360°		ISO	
50.0 m							
		10.1 m			19.0 m		
		0°	20°	40°	0°	20°	40°
m		t	t	t	t	t	t
12		6.5	-	-	-	-	-
14		6.5	-	-	3.5	-	-
16		6.5	6.5	-	3.5	-	-
18		6.3	6.5	-	3.5	-	-
20		5.1	5.8	5.8	3.5	-	-
22		4.1	4.8	5.3	3.5	3.3	-
24		3.3	3.9	4.4	3.2	3.2	-
26		2.6	3.2	3.6	2.6	3.2	3.1
28		2.1	2.5	2.9	2.0	2.9	3.0
30		1.6	2.0	2.4	1.6	2.4	3.0
32		1.2	1.6	1.9	1.2	1.9	2.5
34		0.8	1.2	1.4	0.8	1.5	2.1
36		-	0.8	1.1	-	1.1	1.7
38		-	-	-	-	0.8	1.3
40		-	-	-	-	-	1.0

45.2 m							
		10.1 m			19.0 m		
		0°	20°	40°	0°	20°	40°
m		t	t	t	t	t	t
12		8.0	-	-	4.2	-	-
14		7.7	7.4	-	4.2	-	-
16		7.5	7.1	-	4.1	-	-
18		6.9	6.7	6.2	4.0	-	-
20		5.8	6.3	5.9	3.9	3.6	-
22		4.8	5.3	5.6	3.8	3.5	-
24		3.9	4.4	4.9	3.7	3.4	3.2
26		3.2	3.7	4.1	3.2	3.3	3.2
28		2.6	3.1	3.4	2.6	3.3	3.1
30		2.1	2.5	2.7	2.1	2.9	3.0
32		1.6	2.0	2.2	1.7	2.4	3.0
34		1.2	1.5	1.7	1.3	1.9	2.5
36		0.9	1.2	1.3	1.0	1.6	2.0
38		-	0.8	1.0	0.8	1.2	1.7
40		-	-	-	-	1.0	1.3
42		-	-	-	-	-	1.0

41.8 m							
		10.1 m			19.0 m		
		0°	20°	40°	0°	20°	40°
m		t	t	t	t	t	t
9		10.2	-	-	-	-	-
10		10.1	-	-	5.1	-	-
12		9.7	-	-	5.0	-	-
14		9.4	8.3	-	4.8	-	-
16		8.0	8.0	7.3	4.7	-	-
18		6.5	7.3	7.1	4.5	4.1	-
20		5.4	6.1	6.6	4.4	3.9	-
22		4.4	5.0	5.5	4.2	3.8	3.5
24		3.5	4.1	4.5	3.7	3.7	3.4
26		2.8	3.3	3.7	3.0	3.6	3.3
28		2.2	2.6	2.9	2.4	3.2	3.2
30		1.6	2.0	2.3	1.9	2.7	3.2
32		1.2	1.5	1.8	1.5	2.2	2.8
34		0.8	1.1	1.3	1.1	1.7	2.3
36		-	0.7	0.9	0.8	1.3	1.8
38		-	-	-	-	1.0	1.4
40		-	-	-	-	-	1.0
42		-	-	-	-	-	-

11.9 m							
		10.1 m			19.0 m		
		0°	20°	40°	0°	20°	40°
m		t	t	t	t	t	t
3		13.4	-	-	8.0	-	-
4		13.4	-	-	7.9	-	-
5		13.4	12.6	-	7.7	-	-
6		13.4	11.8	-	7.6	-	-
7		13.2	11.1	-	7.3	-	-
8		12.6	10.6	8.9	7.1	-	-
9		12.0	10.0	8.6	6.8	-	-
10		11.4	9.5	8.3	6.5	5.7	-
12		10.2	8.7	7.9	6.0	5.2	-
14		9.2	8.1	7.5	5.5	4.9	4.3
16		8.4	7.6	7.4	5.0	4.5	4.1
18		7.7	7.4	-	4.7	4.2	3.9
20		-	-	-	4.4	3.9	3.7
22		-	-	-	4.1	3.8	3.6
24		-	-	-	3.8	3.6	3.5
26		-	-	-	3.6	3.5	-

油圧オフセット式補助ジブ

5.4 t 8.10 m x 7.20 m 360° ISO

50.0 m

m	10.1 m			19.0 m		
	0°	20°	40°	0°	20°	40°
12	6.5	-	-	-	-	-
14	6.5	-	-	3.5	-	-
16	5.8	6.5	-	3.5	-	-
18	4.5	5.3	-	3.5	-	-
20	3.4	4.2	4.8	3.3	-	-
22	2.6	3.2	3.8	2.5	3.3	-
24	1.9	2.5	3.0	1.9	2.9	-
26	1.4	1.9	2.3	1.3	2.3	3.1
28	0.9	1.4	1.8	0.9	1.8	2.6
30	-	0.9	1.3	-	1.3	2.0
32	-	-	0.9	-	0.9	1.5
34	-	-	-	-	-	1.1
36	-	-	-	-	-	0.8

45.2 m

m	10.1 m			19.0 m		
	0°	20°	40°	0°	20°	40°
12	8.0	-	-	4.2	-	-
14	7.7	7.4	-	4.2	-	-
16	6.5	7.1	-	4.1	-	-
18	5.2	5.9	6.2	4.0	-	-
20	4.1	4.8	5.4	3.9	3.6	-
22	3.2	3.8	4.3	3.2	3.5	-
24	2.5	3.1	3.5	2.5	3.4	3.2
26	1.9	2.4	2.8	1.9	2.8	3.2
28	1.5	1.9	2.2	1.4	2.2	3.0
30	1.1	1.4	1.7	1.0	1.8	2.4
32	0.7	1.0	1.3	0.7	1.4	1.9
34	-	-	0.9	-	1.0	1.5
36	-	-	-	-	-	1.2
38	-	-	-	-	-	0.8

41.8 m

m	10.1 m			19.0 m		
	0°	20°	40°	0°	20°	40°
9	10.2	-	-	-	-	-
10	10.1	-	-	5.1	-	-
12	9.7	-	-	5.0	-	-
14	7.7	8.3	-	4.8	-	-
16	6.0	6.9	7.3	4.7	-	-
18	4.8	5.6	6.2	4.5	4.1	-
20	3.8	4.4	5.0	3.8	3.9	-
22	2.9	3.5	4.0	3.0	3.8	3.5
24	2.2	2.7	3.2	2.3	3.3	3.4
26	1.6	2.1	2.5	1.7	2.6	3.3
28	1.1	1.5	1.9	1.2	2.1	2.8
30	-	1.1	1.3	0.8	1.8	2.3
32	-	-	0.9	-	1.2	1.8
34	-	-	-	-	0.8	1.3
36	-	-	-	-	-	0.9

11.9 m

m	10.1 m			19.0 m		
	0°	20°	40°	0°	20°	40°
3	13.4	-	-	8.0	-	-
4	13.4	-	-	7.9	-	-
5	13.4	12.6	-	7.7	-	-
6	13.4	11.8	-	7.6	-	-
7	13.2	11.1	-	7.3	-	-
8	12.6	10.6	8.9	7.1	-	-
9	12.0	10.0	8.6	6.8	-	-
10	11.4	9.5	8.3	6.5	5.7	-
12	10.2	8.7	7.9	6.0	5.2	-
14	9.2	8.1	7.5	5.5	4.9	4.3
16	8.4	7.6	7.4	5.0	4.5	4.1
18	6.8	7.0	-	4.7	4.2	3.9
20	-	-	-	4.4	3.9	3.7
22	-	-	-	4.1	3.8	3.6
24	-	-	-	3.8	3.6	3.5
26	-	-	-	3.6	3.5	-

アウトリガ中間張出

26.1 t 8.10 m x 6.00 m 360° ISO

50.0 m

m	10.1 m			19.0 m		
	0°	20°	40°	0°	20°	40°
12	6.5	-	-	-	-	-
14	6.5	-	-	3.5	-	-
16	6.5	6.5	-	3.5	-	-
18	6.5	6.5	-	3.5	-	-
20	6.4	6.2	5.8	3.5	-	-
22	6.0	5.9	5.5	3.5	3.3	-
24	5.5	5.6	5.3	3.4	3.2	-
26	4.7	5.1	5.1	3.3	3.2	3.1
28	4.1	4.4	4.7	3.3	3.1	3.0
30	3.5	3.8	4.0	3.2	3.0	3.0
32	3.0	3.3	3.5	3.2	3.0	2.9
34	2.6	2.8	3.0	2.7	2.9	2.8
36	2.2	2.4	2.6	2.4	2.8	2.8
38	1.8	2.1	2.2	2.0	2.4	2.7
40	1.5	1.7	1.9	1.7	2.1	2.4
42	1.2	1.4	1.5	1.4	1.8	2.1
44	0.9	1.1	1.2	1.1	1.5	1.8
46	-	0.8	0.9	0.8	1.2	1.4
48	-	-	-	-	0.9	1.1
50	-	-	-	-	-	0.9

45.2 m

m	10.1 m			19.0 m		
	0°	20°	40°	0°	20°	40°
12	8.0	-	-	4.2	-	-
14	7.7	7.4	-	4.2	-	-
16	7.5	7.1	-	4.1	-	-
18	7.2	6.7	6.2	4.0	-	-
20	6.7	6.3	5.9	3.9	3.6	-
22	6.2	5.9	5.6	3.8	3.5	-
24	5.7	5.6	5.3	3.7	3.4	3.2
26	5.0	5.3	5.1	3.6	3.3	3.2
28	4.3	4.6	4.9	3.5	3.3	3.1
30	3.8	4.0	4.2	3.4	3.2	3.0
32	3.3	3.5	3.7	3.3	3.1	3.0
34	2.9	3.1	3.2	3.0	3.0	2.9
36	2.5	2.7	2.8	2.6	2.9	2.8
38	2.1	2.3	2.4	2.3	2.7	2.7
40	1.8	2.0	2.1	2.0	2.3	2.6
42	1.5	1.7	1.8	1.7	2.0	2.3
44	1.2	1.4	1.4	1.4	1.8	2.0
46	1.0	1.1	-	1.1	1.5	1.7
48	0.7	0.8	-	0.9	1.2	1.4
50	-	-	-	-	0.9	1.1
52	-	-	-	-	0.7	0.8

41.8 m

m	10.1 m			19.0 m		
	0°	20°	40°	0°	20°	40°
9	10.2	-	-	-	-	-
10	10.1	-	-	5.1	-	-
12	9.7	-	-	5.0	-	-
14	9.4	8.3	-	4.8	-	-
16	9.0	8.0	7.3	4.7	-	-
18	8.5	7.7	7.1	4.5	4.1	-
20	7.6	7.4	6.9	4.4	3.9	-
22	6.4	6.9	6.8	4.2	3.8	3.5
24	5.4	5.9	6.2	4.1	3.7	3.4
26	4.7	5.0	5.3	3.9	3.6	3.3
28	4.0	4.3	4.6	3.8	3.5	3.2
30	3.4	3.7	3.9	3.7	3.4	3.2
32	2.9	3.2	3.4	3.2	3.3	3.1
34	2.5	2.7	2.9	2.8	3.2	3.1
36	2.1	2.3	2.5	2.4	2.8	3.0
38	1.7	2.0	2.1	2.0	2.4	2.7
40	1.4	1.6	1.7	1.7	2.1	2.3
42	1.1	1.3	-	1.4	1.8	2.0
44	0.8	0.9	-	1.1	1.4	1.7
46	-	-	-	0.8	1.1	1.3
48	-	-	-	-	0.9	1.0
50	-	-	-	-	-	0.7

11.9 m

m	10.1 m			19.0 m		
	0°	20°	40°	0°	20°	40°
3	13.4	-	-	8.0	-	-
3.5	13.4	-	-	8.0	-	-
4	13.4	-	-	7.9	-	-
4.5	13.4	-	-	7.8	-	-
5	13.4	12.6	-	7.7	-	-
6	13.4	11.8	-	7.6	-	-
7	13.2	11.1	-	7.3	-	-
8	12.6	10.6	8.9	7.1	-	-
9	12.0	10.0	8.6	6.8	-	-
10	11.4	9.5	8.3	6.5	5.7	-
12	10.2	8.7	7.9	6.0	5.2	-
14	9.2	8.1	7.5	5.5	4.9	4.3
16	8.4	7.6	7.4	5.0	4.5	4.1
18	7.7	7.4	-	4.7	4.2	3.9
20	-	-	-	4.4	3.9	3.7
22	-	-	-	4.1	3.8	3.6
24	-	-	-	3.8	3.6	3.5
26	-	-	-	3.6	3.5	-

油圧オフセット式補助ジブ

アウトリガ中間張出

10.1 t		8.10 m x 6.00 m		360°		ISO	
50.0 m							
		10.1 m			19.0 m		
		0°	20°	40°	0°	20°	40°
m		t	t	t	t	t	t
12		6.5	-	-	-	-	-
14		6.4	-	-	3.5	-	-
16		5.1	5.9	-	3.5	-	-
18		4.1	4.8	-	3.5	-	-
20		3.2	3.9	4.4	3.2	-	-
22		2.5	3.1	3.6	2.5	3.3	-
24		1.9	2.4	2.9	1.9	2.9	-
26		1.4	1.9	2.3	1.4	2.3	3.1
28		1.0	1.4	1.7	0.9	1.8	2.5
30		-	1.0	1.3	-	1.3	2.0
32		-	-	0.9	-	0.9	1.6
34		-	-	-	-	-	1.2
36		-	-	-	-	-	0.8
45.2 m							
		10.1 m			19.0 m		
		0°	20°	40°	0°	20°	40°
m		t	t	t	t	t	t
12		8.0	-	-	4.2	-	-
14		7.2	7.4	-	4.2	-	-
16		5.8	6.6	-	4.1	-	-
18		4.7	5.4	6.0	4.0	-	-
20		3.8	4.4	4.9	3.8	3.6	-
22		3.1	3.6	4.1	3.1	3.5	-
24		2.5	3.0	3.3	2.5	3.4	3.2
26		2.0	2.4	2.7	2.0	2.8	3.2
28		1.5	1.9	2.2	1.5	2.3	2.9
30		1.1	1.4	1.7	1.1	1.8	2.4
32		0.8	1.1	1.3	0.8	1.4	1.9
34		-	0.7	0.9	-	1.0	1.5
36		-	-	-	-	0.7	1.2
38		-	-	-	-	-	0.8

41.8 m							
		10.1 m			19.0 m		
		0°	20°	40°	0°	20°	40°
m		t	t	t	t	t	t
9		10.2	-	-	-	-	-
10		10.1	-	-	5.1	-	-
12		8.6	-	-	5.0	-	-
14		6.8	7.8	-	4.8	-	-
16		5.4	6.3	7.0	4.7	-	-
18		4.3	5.0	5.7	4.4	4.1	-
20		3.4	4.1	4.6	3.5	3.9	-
22		2.7	3.3	3.7	2.8	3.8	3.5
24		2.1	2.6	3.0	2.2	3.1	3.4
26		1.5	2.0	2.3	1.7	2.5	3.3
28		1.1	1.5	1.8	1.2	2.0	2.7
30		-	1.0	1.3	0.8	1.5	2.1
32		-	-	0.9	-	1.1	1.7
34		-	-	-	-	0.8	1.3
36		-	-	-	-	-	0.9

11.9 m							
		10.1 m			19.0 m		
		0°	20°	40°	0°	20°	40°
m		t	t	t	t	t	t
3		13.4	-	-	8.0	-	-
3.5		13.4	-	-	8.0	-	-
4		13.4	-	-	7.9	-	-
4.5		13.4	-	-	7.8	-	-
5		13.4	12.6	-	7.7	-	-
6		13.4	11.8	-	7.6	-	-
7		13.2	11.1	-	7.3	-	-
8		12.6	10.6	8.9	7.1	-	-
9		12.0	10.0	8.6	6.8	-	-
10		11.4	9.5	8.3	6.5	5.7	-
12		10.2	8.7	7.9	6.0	5.2	-
14		9.0	8.1	7.5	5.5	4.9	4.3
16		7.3	7.6	7.4	5.0	4.5	4.1
18		6.0	6.1	-	4.7	4.2	3.9
20		-	-	-	4.4	3.9	3.7
22		-	-	-	4.1	3.8	3.6
24		-	-	-	3.8	3.6	3.5
26		-	-	-	3.6	3.5	-

油圧オフセット式補助ジブ

アウトリガ中間張出

5.4 t 8.10 m x 6.00 m 360° ISO

50.0 m

m	10.1 m			19.0 m		
	0°	20°	40°	0°	20°	40°
12	5.9	-	-	-	-	-
14	4.5	-	-	3.5	-	-
16	3.5	4.2	-	3.4	-	-
18	2.6	3.3	-	2.6	-	-
20	1.9	2.5	3.0	1.8	-	-
22	1.3	1.8	2.3	1.2	-	-
24	0.8	1.3	1.7	-	-	-
26	-	0.8	1.2	-	-	-
28	-	-	0.7	-	-	-

45.2 m

m	10.1 m			19.0 m		
	0°	20°	40°	0°	20°	40°
12	6.8	-	-	4.2	-	-
14	5.3	6.1	-	4.2	-	-
16	4.1	4.9	-	4.0	-	-
18	3.2	3.9	4.4	3.2	-	-
20	2.5	3.0	3.5	2.5	3.5	-
22	1.8	2.4	2.8	1.8	2.8	-
24	1.3	1.8	2.2	1.3	2.2	3.0
26	0.9	1.3	1.6	0.8	1.7	2.4
28	-	0.9	1.2	-	1.2	1.9
30	-	-	0.7	-	0.8	1.4
32	-	-	-	-	-	1.1

41.8 m

m	10.1 m			19.0 m		
	0°	20°	40°	0°	20°	40°
9	9.8	-	-	-	-	-
10	8.5	-	-	5.1	-	-
12	6.4	-	-	5.0	-	-
14	4.9	-	-	4.8	-	-
16	3.7	5.3	5.7	3.8	-	-
18	2.8	4.1	4.6	2.9	4.1	-
20	2.0	3.2	3.6	2.2	3.3	-
22	1.4	2.4	2.9	1.6	2.6	3.5
24	0.9	1.8	2.2	1.0	2.0	2.8
26	-	1.2	1.7	-	1.4	2.2
28	-	0.7	1.2	-	1.0	1.7
30	-	-	0.8	-	-	1.2
32	-	-	-	-	-	0.8

11.9 m

m	10.1 m			19.0 m		
	0°	20°	40°	0°	20°	40°
3	13.4	-	-	8.0	-	-
4	13.4	-	-	7.9	-	-
5	13.4	12.6	-	7.7	-	-
6	13.4	11.8	-	7.6	-	-
7	13.2	11.1	-	7.3	-	-
8	12.6	10.6	8.9	7.1	-	-
9	12.0	10.0	8.6	6.8	-	-
10	11.4	9.5	8.3	6.5	5.7	-
12	9.5	8.7	7.9	6.0	5.2	-
14	7.3	7.7	7.5	5.5	4.9	4.3
16	5.7	6.0	6.3	5.0	4.5	4.1
18	4.6	4.8	-	4.7	4.2	3.9
20	-	-	-	4.4	3.9	3.7
22	-	-	-	3.7	3.8	3.6
24	-	-	-	3.2	3.4	3.5
26	-	-	-	2.7	2.9	-

HAVHY-VA

AC120/4J

油圧オフセット式追加補助ジブ ※追加オプション仕様

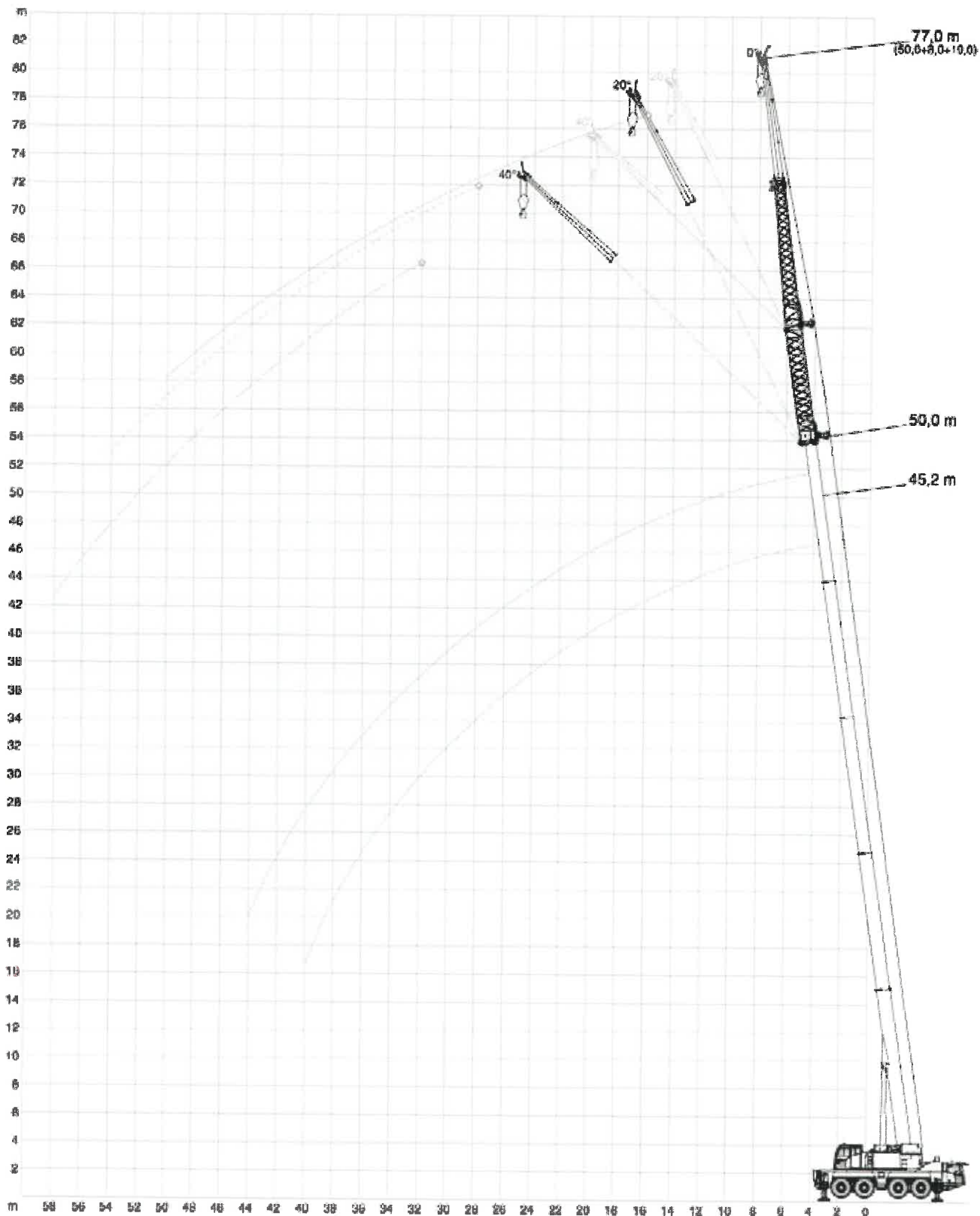

* ジブ作業時の吊上荷重は1条掛けの場合ジブ強度上20%減トンされますのでご注意ください。

油圧オフセット式追加補助ジブ ※追加オプション仕様

26,1 t 8.10 m x 7.20 m 360° ISO

50.0 m

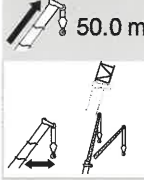

m	t	8 m		
		0°	0°	0°
m	t	19 m		
		0°	20°	40°
16	2.0	-	-	-
18	2.0	-	-	-
20	2.0	-	-	-
22	2.0	-	-	-
24	2.0	1.9	-	-
26	2.0	1.9	-	-
28	2.0	1.9	2.0	-
30	2.0	1.9	2.0	-
32	2.0	1.9	2.0	-
34	2.0	1.9	2.0	-
36	2.0	1.9	2.0	-
38	2.0	1.8	1.9	-
40	1.8	1.8	1.8	-
42	1.5	1.7	1.7	-
44	1.2	1.6	1.6	-
46	1.0	1.4	1.5	-
48	0.7	1.1	1.4	-
50	-	0.9	1.1	-
52	-	-	0.9	-

45.2 m

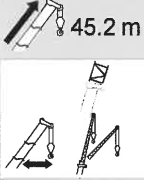

m	t	8 m		
		0°	0°	0°
m	t	19 m		
		0°	20°	40°
14	2.7	-	-	-
16	2.7	-	-	-
18	2.7	-	-	-
20	2.7	-	-	-
22	2.7	2.6	-	-
24	2.7	2.6	-	-
26	2.6	2.5	-	-
28	2.5	2.5	2.4	-
30	2.5	2.4	2.3	-
32	2.4	2.3	2.2	-
34	2.3	2.2	2.1	-
36	2.2	2.0	2.0	-
38	2.0	1.9	1.9	-
40	1.9	1.8	1.8	-
42	1.8	1.7	1.7	-
44	1.6	1.6	1.6	-
46	1.3	1.5	1.5	-
48	1.1	1.4	1.4	-
50	0.8	1.2	1.4	-
52	-	0.9	1.1	-
54	-	-	0.8	-

41.8 m



m	t	8 m				
		0°	0°	0°	20°	40°
m	t	19 m				
		0°	20°	40°	0°	0°
14	3.7	-	-	-	-	-
16	3.7	-	-	-	-	-
18	3.6	-	-	-	-	-
20	3.5	3.3	-	-	-	-
22	3.4	3.1	-	-	-	-
24	3.2	3.0	-	2.7	-	-
26	3.1	2.9	2.7	2.6	-	-
28	3.0	2.7	2.6	2.5	-	-
30	2.8	2.6	2.5	2.4	1.9	-
32	2.7	2.5	2.4	2.3	1.9	-
34	2.6	2.4	2.3	2.2	1.8	-
36	2.5	2.3	2.3	2.1	1.8	-
38	2.4	2.3	2.2	2.0	1.7	-
40	2.1	2.2	2.1	1.9	1.7	-
42	1.7	2.1	2.1	1.9	1.6	-
44	1.4	1.8	2.0	1.8	1.6	-
46	1.1	1.5	1.8	1.6	1.6	-
48	0.8	1.2	1.5	1.3	1.6	-
50	-	0.9	1.1	1.0	1.4	-
52	-	-	0.9	0.8	1.1	-
54	-	-	-	-	0.8	-

37.5 m



m	t	8 m				
		0°	0°	0°	20°	40°
m	t	19 m				
		0°	20°	40°	0°	0°
12	4.5	-	-	-	-	-
14	4.4	-	-	-	-	-
16	4.2	-	-	-	-	-
18	4.0	3.6	-	-	-	-
20	3.8	3.5	-	-	-	-
22	3.6	3.3	-	2.9	-	-
24	3.5	3.1	2.9	2.8	-	-
26	3.3	3.0	2.8	2.7	-	-
28	3.1	2.9	2.7	2.6	2.1	-
30	3.0	2.7	2.6	2.4	2.0	-
32	2.8	2.6	2.5	2.3	1.9	-
34	2.7	2.5	2.4	2.2	1.9	-
36	2.6	2.4	2.3	2.1	1.8	-
38	2.5	2.3	2.2	2.1	1.8	-
40	2.2	2.2	2.2	2.0	1.7	-
42	2.1	2.1	2.1	1.9	1.7	-
44	1.9	2.0	2.0	1.8	1.7	-
46	1.8	1.8	1.9	1.7	1.6	-
48	1.5	1.7	1.8	1.6	1.6	-
50	1.3	1.6	1.6	1.5	1.4	-
52	1.1	1.3	1.4	1.4	1.0	-
54	0.9	1.1	-	1.1	0.7	-
56	-	0.8	-	0.9	-	-

11.9 m

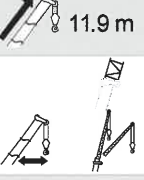

m	t	8 m				
		0°	0°	0°	20°	40°
m	t	19 m				
		0°	20°	40°	0°	0°
4.5	6.8	-	-	-	-	-
5	6.7	-	-	-	-	-
6	6.6	-	-	-	-	-
7	6.4	-	-	-	-	-
8	6.3	-	-	-	-	-
9	6.1	-	-	-	-	-
10	5.8	-	-	-	-	-
11	5.2	-	-	-	-	-
12	4.7	4.8	-	-	-	-
14	4.3	4.4	-	4.0	-	-
16	3.9	4.0	3.8	3.6	-	-
18	3.5	3.6	3.5	3.3	-	-
20	3.2	3.3	3.2	3.1	-	-
22	3.0	3.1	3.0	2.8	2.4	-
24	2.7	2.8	2.8	2.6	2.3	-
26	2.5	2.6	2.6	2.4	2.2	-
28	2.3	2.4	2.4	2.2	2.0	-
30	2.1	2.3	2.3	2.1	1.9	-
32	2.0	2.1	-	2.0	1.9	-
34	-	2.0	-	1.9	-	-

油圧オフセット式追加補助ジブ ※追加オプション仕様

アウトリガ中間張出

26.1 t					8.10 m x 6.00 m					360°					ISO				
8 m																			
0° 0° 0°																			
19 m																			
0° 20° 40°																			
m	t	t	t	t	m	t	t	t	t	m	t	t	t	t					
16	2.0	-	-	-	14	2.7	-	-	-	14	3.7	-	-	-					
18	2.0	-	-	-	16	2.7	-	-	-	16	3.7	-	-	-					
20	2.0	-	-	-	18	2.7	-	-	-	18	3.6	-	-	-					
22	2.0	-	-	-	20	2.7	-	-	-	20	3.5	3.3	-	-					
24	2.0	1.9	-	-	22	2.7	2.6	-	-	22	3.4	3.1	-	-					
26	2.0	1.9	-	-	24	2.7	2.6	-	-	24	3.2	3.0	-	2.7					
28	2.0	1.9	2.0	-	26	2.6	2.5	-	-	26	3.1	2.9	2.7	2.6					
30	2.0	1.9	2.0	2.0	28	2.5	2.5	2.4	-	28	3.0	2.7	2.6	2.5					
32	2.0	1.9	2.0	-	30	2.5	2.4	2.3	-	30	2.8	2.6	2.5	2.4					
34	2.0	1.9	2.0	-	32	2.4	2.3	2.2	-	32	2.7	2.5	2.4	2.3					
36	1.7	1.9	2.0	-	34	2.3	2.2	2.1	-	34	2.5	2.4	2.3	2.2					
38	1.3	1.8	1.9	-	36	2.2	2.0	2.0	-	36	2.1	2.3	2.3	2.1					
40	1.0	1.6	1.8	-	38	1.9	1.9	1.9	-	38	1.7	1.9	2.2	2.0					
42	0.7	1.3	1.7	-	40	1.5	1.8	1.8	-	40	1.4	1.5	2.1	1.9					
44	-	1.0	1.4	-	42	1.2	1.7	1.7	-	42	1.0	1.2	1.9	1.7					
46	-	0.7	1.1	-	44	1.0	1.4	1.6	-	44	0.7	0.9	1.5	1.3					
48	-	-	0.8	-	46	0.7	1.1	1.4	-	46	-	-	1.2	1.0					
					48	-	0.8	1.1	-	48	-	-	0.9	0.7					
					50	-	-	0.8	-	50	-	-	-	0.8					

8 m														
0° 0° 0°														
19 m														
0° 20° 40°														
m	t	t	t	t	m	t	t	t	t					
12	4.5	-	-	-	12	4.7	4.8	-	-					
14	4.4	-	-	-	14	4.3	4.4	-	4.0					
16	4.2	-	-	-	16	3.9	4.0	3.8	3.6					
18	4.0	3.6	-	-	18	3.5	3.6	3.5	3.3					
20	3.8	3.5	-	-	20	3.2	3.3	3.2	3.1					
22	3.6	3.3	-	2.9	22	3.0	3.1	3.0	2.8					
24	3.5	3.1	2.9	2.8	24	2.7	2.8	2.8	2.6					
26	3.3	3.0	2.8	2.7	26	2.5	2.5	2.6	2.4					
28	3.1	2.9	2.7	2.6	28	2.3	2.4	2.4	2.2					
30	3.0	2.7	2.6	2.4	30	2.1	2.3	2.3	2.1					
32	2.8	2.6	2.5	2.3	32	2.0	2.1	-	2.0					
34	2.6	2.5	2.4	2.2	34	-	2.0	-	1.9					
36	2.5	2.4	2.3	2.1										
38	2.3	2.3	2.2	2.1										
40	2.1	2.1	2.2	2.0										
42	1.8	2.1	2.1	1.9										
44	1.5	1.8	2.0	1.8										
46	1.2	1.5	1.7	1.6										
48	1.0	1.2	1.4	1.3										
50	0.7	1.0	1.1	1.1										
52	-	0.8	0.9	0.8										

8 m														
0° 0° 0°														
19 m														
0° 20° 40°														
m	t	t	t	t	m	t	t	t	t					
4.5	6.8	-	-	-	4.5	6.8	-	-	-					
5	6.7	-	-	-	5	6.7	-	-	-					
6	6.6	-	-	-	6	6.6	-	-	-					
7	6.4	-	-	-	7	6.4	-	-	-					
8	6.3	-	-	-	8	6.3	-	-	-					
9	6.1	-	-	-	9	6.1	-	-	-					
10	5.8	-	-	-	10	5.8	-	-	-					
11	5.2	-	-	-	11	5.2	-	-	-					
12	4.7	4.8	-	-	12	4.7	4.8	-	-					
14	4.3	4.4	-	4.0	14	4.3	4.4	-	4.0					
16	3.9	4.0	3.8	3.6	16	3.9	4.0	3.8	3.6					
18	3.5	3.6	3.5	3.3	18	3.5	3.6	3.5	3.3					
20	3.2	3.3	3.2	3.1	20	3.2	3.3	3.2	3.1					
22	3.0	3.1	3.0	2.8	22	3.0	3.1	3.0	2.8					
24	2.7	2.8	2.8	2.6	24	2.7	2.8	2.8	2.6					
26	2.5	2.5	2.6	2.4	26	2.5	2.5	2.6	2.4					
28	2.3	2.4	2.4	2.2	28	2.3	2.4	2.4	2.2					
30	2.1	2.3	2.3	2.1	30	2.1	2.3	2.3	2.1					
32	2.0	2.1	-	2.0	32	2.0	2.1	-	2.0					
34	-	2.0	-	1.9	34	-	2.0	-	1.9					

技術的な説明

基本装備

キャリア

エンジン	MTU; 出力335kW(455HP), トルク2000Nm, EURO排ガス規制 MOT3a, TIER3, CARB に適合; スパークアレス タ付ステンレス製排気装置 スパークアレスタ付ステンレス製排気装置
燃料タンク	400 ℓディーゼル
トランスミッション	ZF AS-Tronic; 油圧リターダ内蔵自動変速機、前進12段と後進2速; 縦と横のデフロック機構付2-段トランスファー ギヤ
走行機構	選択式縦デフロック機構付トランスファーギヤ 8x6x8; 4軸、1,2,4軸は駆動と選択式デフロック機構装備; 全ての車軸は操舵機構装備
サスペンション	軸重補正機能付き油圧サスペンション; 油圧式ロック可能; 手動又は自動レベル調整機構
ステアリング	緊急ステアリングポンプ付2系統油圧セミブロックステアリング; 後軸(3及び4軸作動により6種類の操舵方式)
ブレーキ	アンチロック装置付2系統エア作動サービスブレーキ 全輪に作動; ディスクブレーキ; 排気及びコンスタント チョークバルブブレーキ; スプリング作動駐車ブレーキ
タイヤ/ホイール	385/95R25 170F(14.00R25); 鋼製リム9.50-25/1.7"CR
キャリア運転室	タイプ2.55m; 暖房付調整可能な運転席、アームレスト及びエアサスペンション; ハンドルの高さ及び角度調整可能 助手席; パワーウインド; 色つきガラス; ラジオ装備; 2回転灯; 格納庫
温水ヒーター	エンジン冷却を使用する温風暖房出力12kW
走行証明灯	ロービーム及びハイビーム付 昼間走行灯
オートクルーズ	自動ブレーキ制御装置付自動速度制御装置
電子イモビライザ装置	盗難防止装置; 電子キー2個とイグニッションキー4個を含む
その他	タイヤ用空気充填プラグ

クレーン

伸縮ブーム	11.9m-50.0m; シングル伸縮シリンダシステム、手動又は自動伸縮システム; 全ての装備品及びエクステンション用 のアタッチメント; ブームヘッドに最大荷重64.5トン用の5シーブ内蔵
カウンタウエイト	21.3t 6個; 自動組立装置; 最大26.1t; 21.3tは標準で走行可能; 4.7tはクレーン後部に取付け
アウトリガ	Hタイプ4点支持; 油圧で垂直と水平作動; キャリア両側面より手動又は自動でレベル調整; アウトリガ張出4か所 スプリング作動多板式ディスクブレーキ装備のホイスト; ロープのよじれ防止; リゾルバ(ホイスト回転検知器)
アウトリガパッド	垂直シリンダの輸送位置に4つのアウトリガパッド A = 0.28m ² を格納
ブーム起伏	自動降下ブレーキバルブを備えた1本起伏用シリンダ
旋回装置	スプリング作動多板式ディスクブレーキ付旋回装置
ホイスト1	スプリング作動多板式ディスクブレーキ付ホイスト装置; リゾルバ(ホイスト回転検知器)
エンジン	MTU; 出力129kW(175HP) トルク675Nm, EURO 排ガス規制 MOT3a, TIER3, CARB に適合; スパークアレス タ付ステンレス製排気装置
燃料タンク	200 ℓディーゼル
駆動	パワー制御付油圧システム; 作動油クーラー
制御装置	4つの同時作業操作が可能; 2つのジョイスティックによる電気パイロット制御
オペレータ支援	EN13000 に適合の過負荷防止装置を内蔵したIC-1; カラー表示; 作業状態の表示; 荷重表; エラー表示; LMI 荷重の信号灯の表示; クレーンデータ記録装置
作業領域制限	IC-1 による作業領域制限の設定と表示
フック高さ表示	パワー制御油圧システム; 作動油クーラー
クレーン運転室	タイプ0.875m; 20°無段階チルト; シート暖房; 前方開閉式フロントウインド; 側面引出し式及び全面折曲式ステップ; 手すり; 色つき安全ガラス; 引き出し式サンバイザとカーテン; エアコンとラジオ装備
温水ヒーター	エンジン冷却を使用する温風暖房出力12kW
その他	
照明	クレーン運転室に作業場用1個、調整可能、アウトリガ用4個
回転灯	キャリア上部に内蔵2個、クレーン後部に2個、脱着可能
工具キット	簡単な修理と整備用工具キット
安全マーク	キャリア側面と後面に黄色反射バンドを連続貼付け
脚立	様々な組立作業用の脚立、輸送時格納装置

技術的な説明

オプション

キャリア

燃焼ヒーター 出力10kWディーゼル式燃焼ヒーター、タイマ及びエンジンブロック暖気とキャリア運転室の切り替え式
エアコン 冷房出力7kWキャリア運転室用エアコンディショナ

クレーン

ホイスト2 スプリング作動多板式ディスクブレーキ; リゾルバ(ホイスト回転検知器); クイックカブラと輸送用格納
自力取付け; 全てのエクステンションジブと2フック操作可能

カウンタウエイト 自力取付け用ウエイト; 合計21.3t 個数6; 最大26.1tに増量可能

追加カウンタウエイト 最大26.1t 総個数 8; 追加ウエイト2.4t × 2個; カウンタウエイト21.3tとの組合せ

アウトリガ荷重表示 クレーン運転席のLMIに表示

アウトリガ張出の監視 プログラムされたアウトリガ張出幅と目視比較のため各アウトリガケースを監視; クレーン運転室のLMIに表示
(注意! LMIシステムとの自動リンクはしていない)

燃焼ヒーター 暖房出力5kWディーゼル式燃焼ヒーター、タイマ及びエンジンブロックとキャリア運転室のLMIに切り替え式

エアコンクレーン 冷房出力7kWクレーン運転室用エアコンディショナ

補助ジブ

HAV19 10m/19m; 二重折りたたみ式振り出しジブ、手動オフセット20°/40°; 1シーブヘッド; 輸送時格納用油圧シリンダ装
置付; HAV10を含む; HA又はVAでの操作

VA8 8m; 追加ジブ、手動オフセット20°/40°; HAV(-HY)19での操作

HAV-HY 油圧作動オフセット0°-40° HAV10とHAV19

使用上の注意

- 1) 定格総荷重は、水平堅土上に設置したときの値で本機の保証できる荷重を示しており、フックその他吊り具重量を含んだ値です。
- 2) 定格総荷重はブームのたわみを含んだ実際の作業半径に基づいております。
- 3) 定格総荷重は風による影響を含んでおりません。
瞬間最大風速が10m/s以上では作業を中止して下さい。
- 4) 掲載の写真・イラストはカタログ用に撮影・作図したものであり、オプション仕様を含めて実際とは異なる場合があります。
- 5) 本仕様は予告なく変更する事があります。
- 6) 本機のご使用にあたっては、取扱説明書を必ずお読みください。
- 7) このカタログに記載されている仕様は日本向けとなっております。

発行日：2016年9月

製品の仕様および価格は通知することなく、またいかなる責任を負うことなく変更することがあります。

本書の写真および図は説明用です。装置の正しい使用に関する説明は適切な取扱説明書を参照してください。

Copyright Terex Cranes 2016



Terex Cranes
Global Marketing
Dinglerstraße 24 · 66482 Zweibrücken/Germany
Phone +49 (0) 6332 830
Email: info.cranes@terex.com

www.terex.com/cranes

DEMAG[®]
A TEREX BRAND